



Installation Instructions

For Part Numbers:

200-196	700-469 Airaid Oiled Media Filter
201-196	701-469 SynthaMax Dry Media Filter - Red
202-196	702-469 SynthaMax Dry Media Filter - Black
203-196	703-469 SynthaMax Dry Media Filter - Blue

2007-08 Cadillac Escalade/ESV/EXT

2007-08 Chevrolet Avalanche

2007-08 Chevrolet Silverado 1500/2500HD/3500HD

2007-08 Chevrolet Tahoe/Suburban 1500/2500

2007-08 GMC Sierra 1500/2500HD/3500HD

2007-08 GMC Yukon/Yukon XL 1500/2500

2007-08 GMC Denali/Denali XL

4.3L V6, 4.8L V8, 5.3L V8, 6.0L V8, 6.2L V8

(GMT-900 Body Style Only)

Component Identification

1.	Airaid Premium Filter	1
2.	MAF Panel Coated	1
3.	Rear Air Dam Coated	1
4.	Black Filter Adapter	1
5.	Weather Strip 20 3/4"	1
6.	1/4"-20x1/2" SS Button Head	3
7.	1/4" Flat Washer	7
8.	M6 x 1.25 Hex Bolt	4
9.	6-32 x 5/16" Screw	5
10.	#6 Flat Washer	5
11.	6-32 Keps Nut	5
12.	Airaid Decal	1

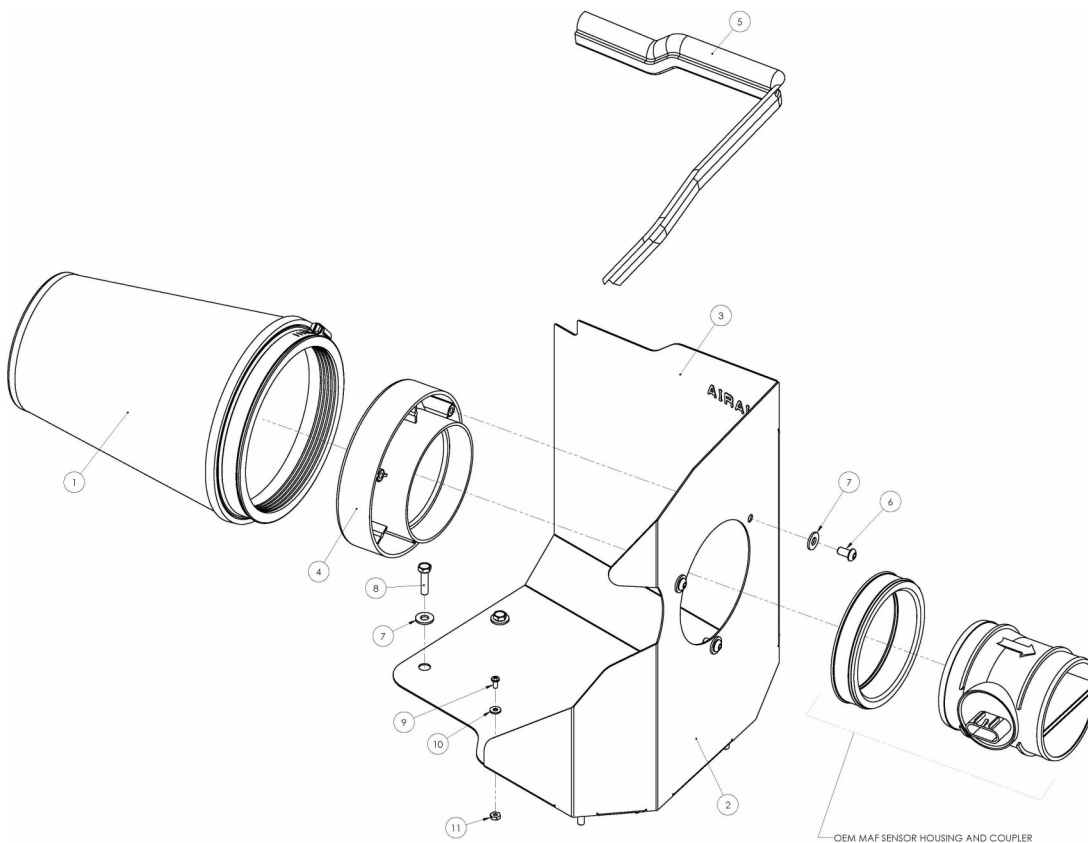

Full color instructions can be viewed on our web site at Airaid.com.

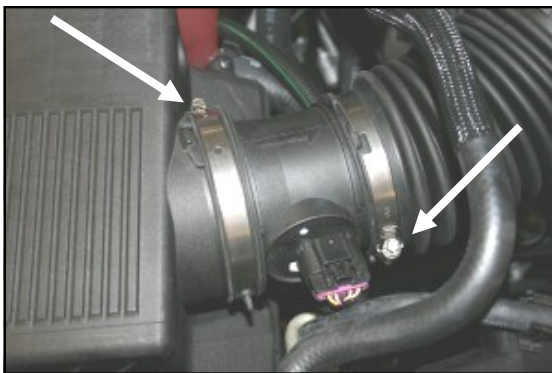

1. **Disconnect the negative battery cable.** Loosen the hose clamp on the end of the factory intake tube at the Mass Air Flow sensor, next loosen the hose clamp that holds the Mass Air Flow sensor to the factory air box.



2. Remove the Mass Air Flow sensor from between the factory intake tube and the factory air box. Use caution to retain the rubber coupler on the Mass Air Flow sensor.



3. Without disconnecting the wiring harness, set the Mass Air Flow sensor out of the work area. Next rock the factory air box back and forth, lift it up, and remove it from the hold down grommets. There are no bolts holding it down.



4. Remove the factory air box from the vehicle.

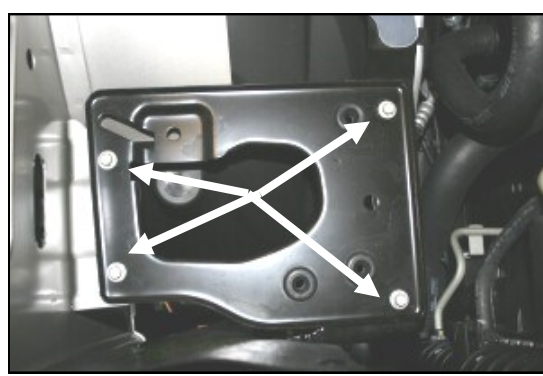

5. Remove 4 bolts, and remove the factory air-box mounting plate.



6. Assemble the two Cool Air Dam panels (#2) and (#3) using the five supplied screws (#9), washers (#10), and nuts (#11). Apply the Airaid Foil Decal onto the Panel as shown.

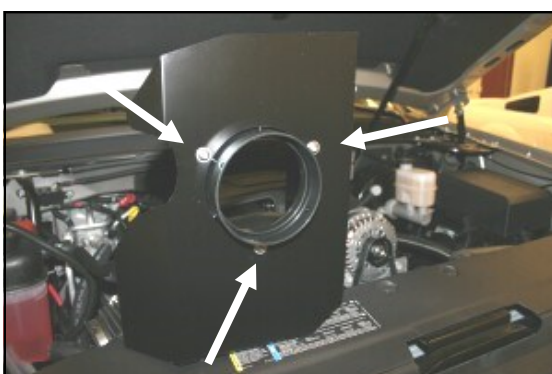

7. Install the filter adapter (#4) into the CAD using three button head bolts (#6), and washers (#7).

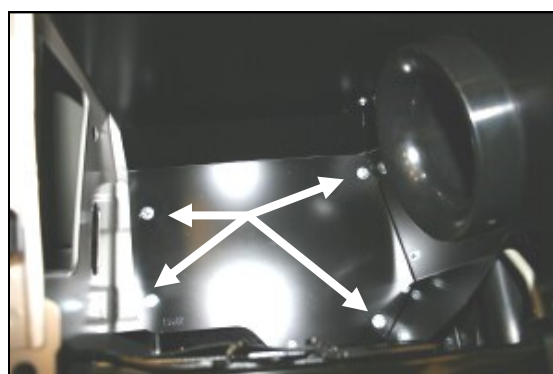

8. Install the assembled CAD in place of the factory airbox using four bolts (#8) and washers (#7). Do not over tighten the bolts.

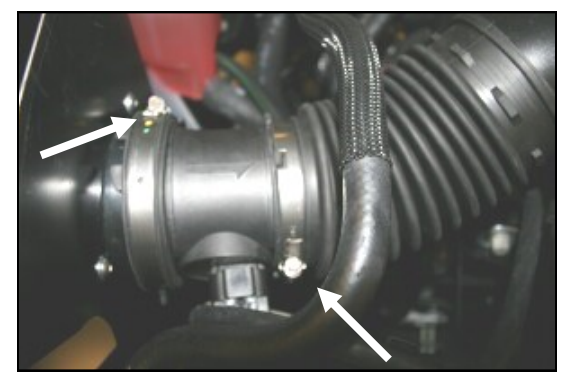

9. Re-install the Mass Air Flow sensor and coupler onto the air filter adapter (#4), as shown and tighten the hose clamp. Next re-connect the factory intake tube to the Mass Air Flow sensor, and tighten the hose clamp.



10. Install the Airaid Premium Filter (#1) onto the filter adapter (#4), and tighten the hose clamp. Next install the weather strip (#5) onto the top of the CAD as shown. For ease of installation start at the fender, and work towards the radiator.

11. Double check your work!

Make sure there is no foreign material in the intake path. Make sure all clamps, hoses, bolts, and screws are tight.

12. Reconnect the negative battery cable!

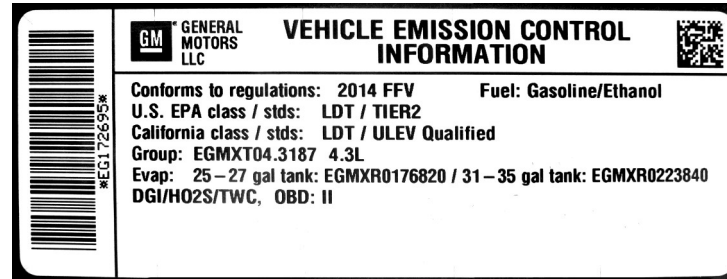

WARNING! If your vehicle has a Vehicle Emission Control Information decal affixed to the factory airbox, a new replacement label must be obtained and installed in a readily visible position in the engine compartment in order to remain CARB compliant. Failure to do so will prevent the vehicle from passing a smog check. Replacement labels can be ordered from your local dealership. Regulations state that the VECI label shall not be affixed to any equipment which is easily detached from the vehicle. Label placement, under the hood on a painted surface is recommended.

Thank you for purchasing the Airaid Intake System. Contact Airaid @ (800) 498-6951 8:00 AM - 5:00 PM MST weekdays for questions regarding fit or instructions that are not clear to you. Your Airaid Intake System was carefully inspected and packaged. Check that no parts are missing, or were damaged during shipping. If any parts are missing, contact Airaid. The air filter element is protected from direct exposure to water and debris; care should be taken not to drive through deep water. WATER INGESTION IS THE DRIVERS RESPONSIBILITY! The air filter is reusable and should be cleaned periodically.

FILTER IDENTIFICATION

700-469 Airaid Oiled Media
702-469 Airaid SynthaMax Dry Media - Black

701-469 Airaid SynthaMax Dry Media - Red
703-469 Airaid SynthaMax Dry Media - Blue

For your Oiled media filter we suggest using the AIRAID Filter Tune-Up Kit!



Do Not Oil



P/N 790-551 Aerosol Spray
P/N 790-550 Squeeze Spray

Synthamax Air Filters do not require oil. Service air filter as needed by cleaning with common non-petroleum all-purpose household cleaner and water. Simple Green®, Formula 409® or equivalent works great. Apply cleaner to outside of air filter and allow to soak. Then flush filter clean from the inside out with a garden hose and repeat steps if necessary. Do not apply high pressure water or air to clean filter. Allow filter to air dry and reinstall.

