

# iBoard®

## iBoard® by APS

PART#: IB-001

READ INSTRUCTIONS CAREFULLY BEFORE STARTING INSTALLATION. REMOVE CONTENTS FROM BOX AND VERIFY ALL PARTS ARE PRESENT. ASSISTANCE IS RECOMMENDED.

\*ROCKER PANEL MOUNT  
\*NO DRILLING REQUIRED

Fastener Size	Tightening Torque (ft-lbs)	Required
6mm	6-7	√
8mm	16-18	X
10mm	31-32	√
12mm	56-58	X
14mm	92-94	X

### PART LIST

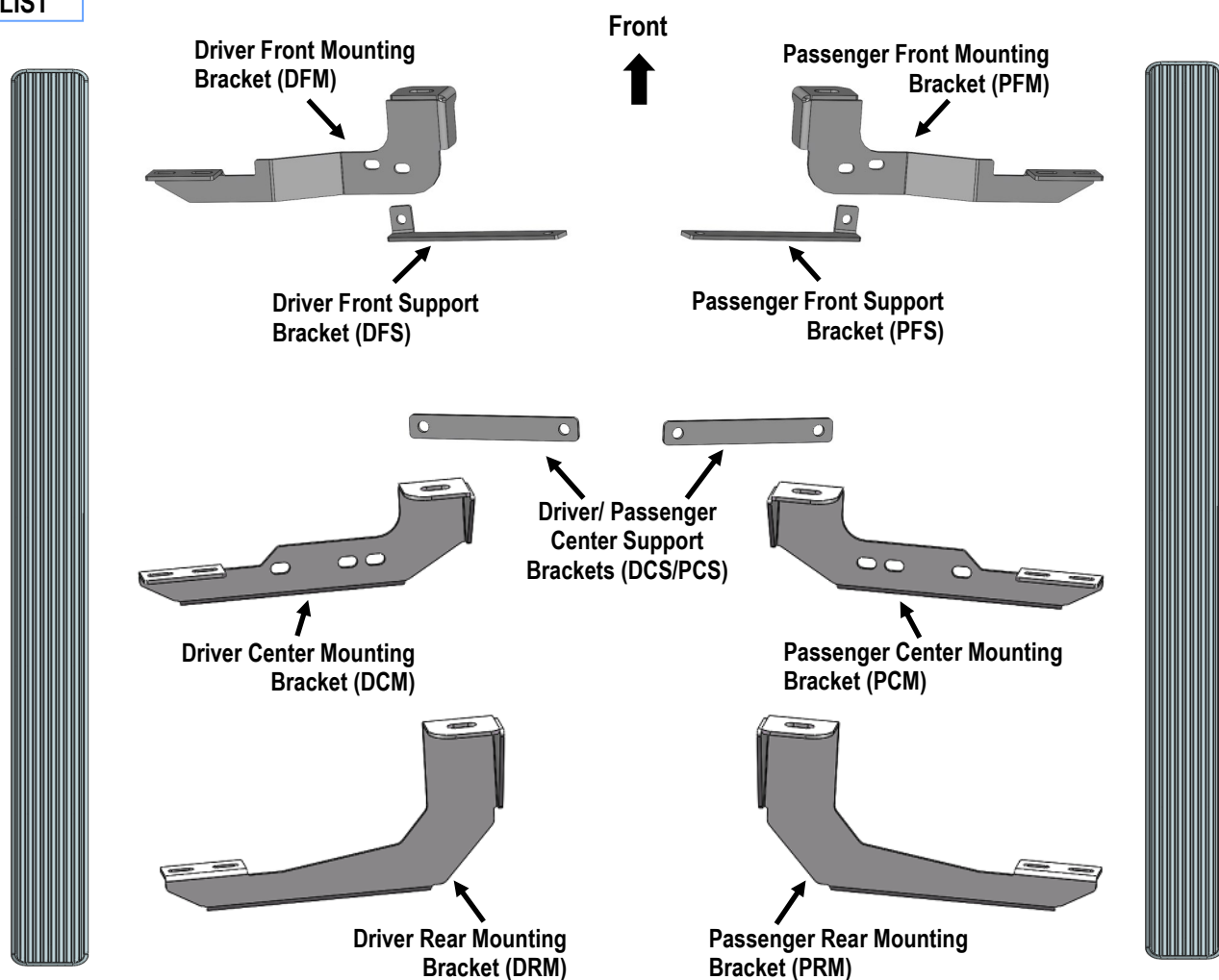

Customer Support: [info@iboardauto.com](mailto:info@iboardauto.com)

# iBoard®

## Hardware Package A (For Bracket Installation)

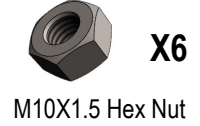
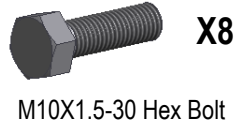
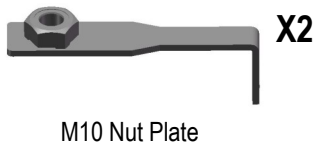

## Hardware Package B (For Aluminum Step Bar Installation Only, Not Supply to Stainless Steel Step Bar)



## Hardware Package C (For Stainless Steel Step Bar Installation Only, Not Supply to Aluminum Step Bar)



## STEP 1

Start the installation from the Passenger Side Front Mounting Location of the vehicle. Remove the front body mount bolt, (Fig 1). Do not remove rubber bushing.

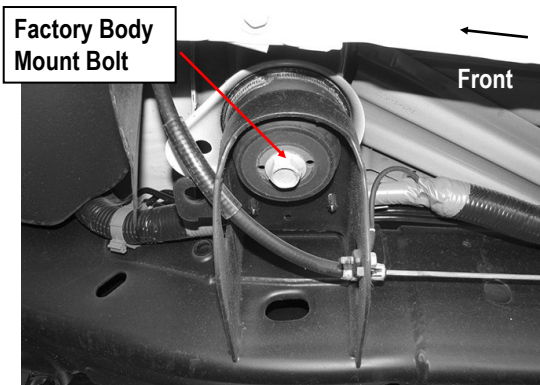

(Fig 1) Passenger Side Front Mounting Location Pictured

## STEP 2

Attach the Passenger Front Mounting Bracket (PFM) to the body mount reusing the factory hex bolt, (Fig 2). Do not fully tighten hardware at this time.

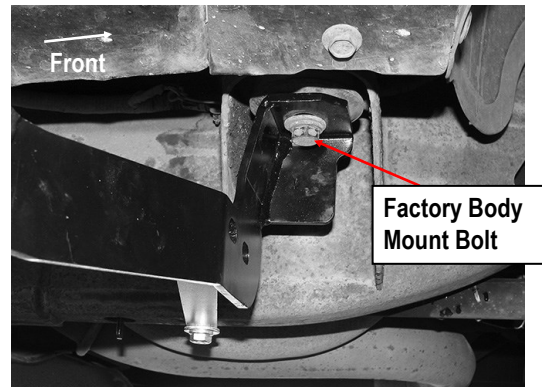

(Fig 2) Passenger Front Mounting Bracket Installed

# iBoard®

## STEP 3

Move to the passenger front support bracket mounting location. Locate the two factory holes at the bottom of the frame close to the Passenger Side Front Mounting Location. Insert (1) M10 Nut Plate into the oval hole and line up the threaded nut with the round hole, (Fig 3). **NOTE:** Nut Plate and Support Brackets are not required on 2011-2014 2500/3500 models.

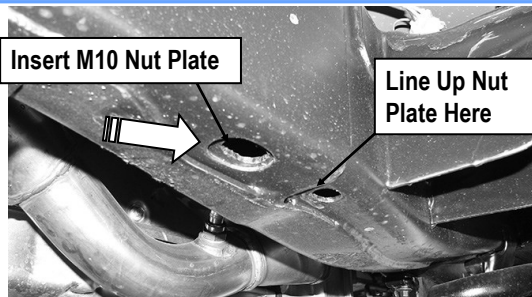

(Fig 3) Passenger Front Support Bracket Mounting Location

## STEP 4

Attach the flat end of the Passenger Front Support Bracket (PFS) to the M10 Nut Plate with (1) M10X1.5-30 Hex Bolt, (1) M10 Large Flat Washer and (1) M10 Lock Washer, (Fig 4 & 5). Do not fully tighten hardware at this time.

### 1500 Models:

Attach the bent end of the Support Bracket onto the Passenger Front Mounting Bracket with (1) M10X1.5-30 Hex Bolt, (2) M10 Large Flat Washers, (1) M10 Lock Washer and (1) M10X1.5 Hex Nut, (Fig 4). Do not fully tighten hardware at this time.

### Up to 2010 2500/3500 Models:

Note that the Front Support Bracket will not reach up to the Mounting Bracket, (Fig 5). Tighten the Support Bracket to the Nut Plate in the frame. Carefully push up on the Support Bracket until it reaches the inside hole in the Mounting Bracket. Bolt the Support Bracket to the hole on the Mounting Bracket with (1) M10X1.5-30 Hex Bolt, (2) M10 Large Flat Washers, (1) M10 Lock Washer and (1) M10X1.5 Hex Nut, (Fig 6). Do not fully tighten at this time.

**Note:** Support Bracket not required on 2011-2014 2500/3500 Models.

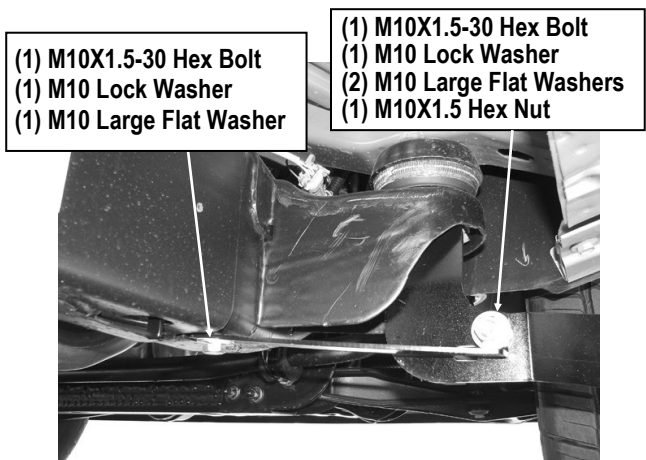

(Fig 4) Passenger Front Support Bracket Installed  
(For 1500 Models)

**NOTE:** Support Brackets not required on 11-14 2500/3500 Models

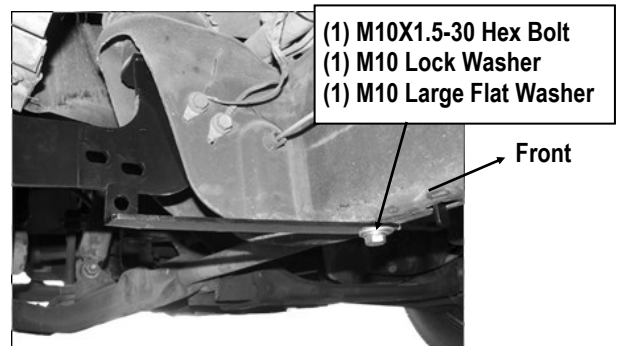

(Fig 5) Passenger Front Support Bracket Installed  
(For 2500/3500 Models)

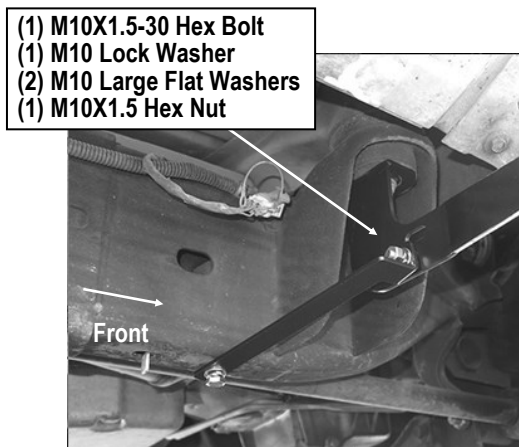

(Fig 6) Passenger Front Support Bracket Installed

# iBoard®

## STEP 5

Move to the Passenger Side Center body mount and remove the factory bolt. Select the Passenger Center Mounting Bracket (**PCM**). Repeat **Step 2** to attach the Passenger Center Mounting Bracket (**PCM**), (**Figs 7 & 8**).

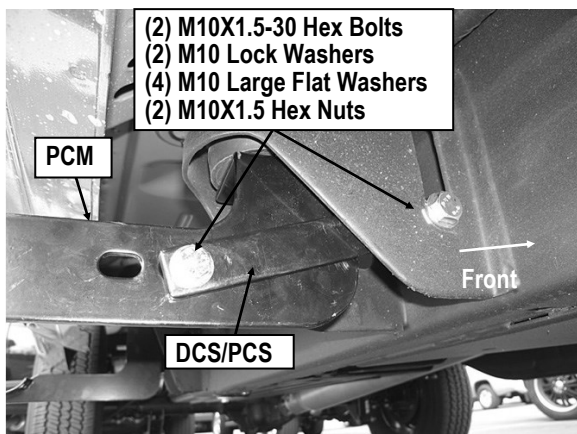

(Fig 7) Passenger Center Mounting Bracket And Passenger Support Bracket Installation (For 1500 Models)

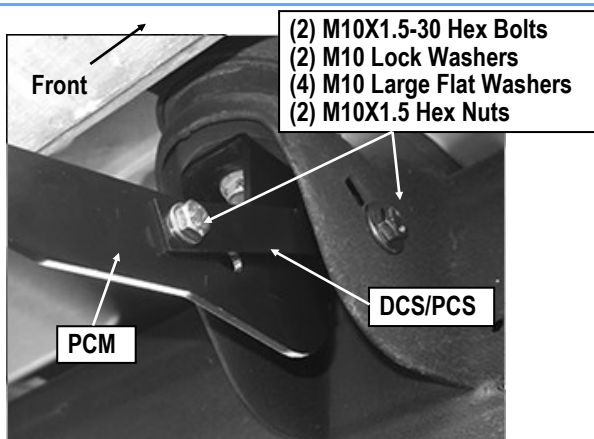

(Fig 8) Passenger Center Mounting Bracket and Passenger Center Support Bracket Installation (For 2500/3500 Models )

## STEP 6

Next, select (1) Passenger Center Support Bracket (**DCS/PCS**). There are two mounting holes on the Support Bracket. Attach

the Support Bracket to the hole beside the body mount with (1) M10X1.5-30 Hex Bolt, (2) M10 Large Flat Washers, (1) M10 Lock Washer and (1) M10X1.5 Hex Nut, (**Figs 7 & 8**). Do not fully tighten at this time.

## STEP 7

Attach the opposite end of the Support Bracket to the Center Bracket with (1) M10X1.5-30mm Hex Bolt, (2) M10 Large Flat Washers, (1) M10 Lock Washer and (1) M10X1.5 Hex Nut, (**Figs 7 & 8**). Do not fully tighten at this time.

## STEP 8

Move to the passenger side rear body mount. Repeat **Steps 1 - 2** to attach the Passenger Rear Mounting Bracket (**PRM**) to the body mount, (**Fig 9**). Leave hardware loose at this time.

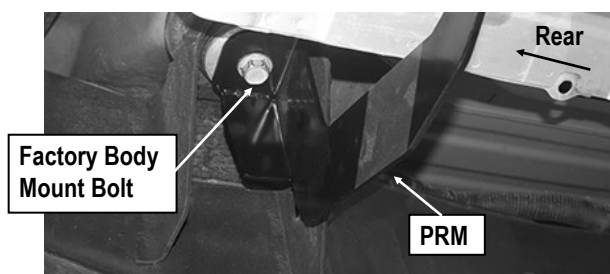

(Fig 9) Passenger Rear Mounting Bracket Installation

## STEP 9

Once all (3) mounting brackets are installed, then proceed to the Step Bar installation. According to the style of Step Bar proceed to the correct installation STEPS.

**Note:** Aluminum Step Bar refer to **STEP 10**; Stainless Steel Step Bar skip to **STEP 11**.

# iBoard®

## STEP 10

### Aluminum Step Bar Installation:

Select a **Aluminum Step Bar**. Slip (3) M6x1-20mm Square Head Bolts into each bottom channel (**Fig 10**). Carefully position the Step Bar onto the (3) Mounting Brackets.

**IMPORTANT:** Do not slide the Step Bar on the Brackets or the bottom surface of the board will be damaged. Attach the Step Bar to each Mounting Brackets with (2) M6x1-20 Square Head Bolts, (2) M6 Large Flat Washers and (2) M6X1 Nylon Lock Nuts, (**Fig 11**). Do not fully tighten at this time.

Level and adjust the Step Bar and fully tighten all hardware. Repeat **Steps 1-10** for the other side Step Bar installation. **The installation is completed!!!**



(Fig 10) Slip M6X1-20 Square Head Bolts Into The Bottom Channels

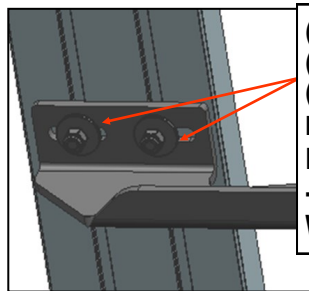

(2) M6X1-20 Square Head Bolts  
(2) M6 Large Flat Washers  
(2) M6X1 Nylon Lock Nuts  
**IMPORTANT: TORQUE FOR 6MM FASTNERS MUST LESS THAN 6-7 FT-LBS OR THE FASTNERS WILL BE DAMAGED!**

(Fig 11) Running Board Installed Onto Mounting Bracket

## STEP 11

### Stainless Steel Step Bar Installation:

Select a **Stainless Steel Step Bar** (with the U-Sliders installed on the Bar). Loose the U-Sliders, reposition the U-Sliders onto the board according to the (3) Installed Mounting Brackets location, (**Fig 12**). Re-secure the U-Sliders on the Step Bar. Attach the Step Bar to the installed Mounting Brackets with (6) M6X1-20 Hex Bolts, (6) M6 Large Flat Washers & (6) M6 Lock Washers, (**Fig 13**). Do not fully tighten hardware at this time.

Level and adjust the Step Bar and fully tighten all hardware. Repeat **Steps 1-9 and 11** for the other side Step Bar installation.

**The installation is completed!!!**

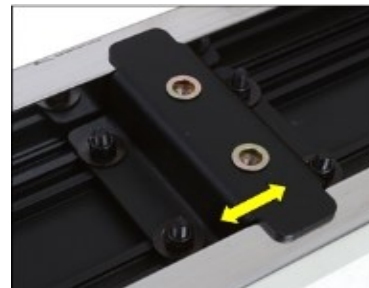

(Fig 12) Slide & line up the U-Slider with the installed mounting brackets along bottom channel

(2) M6X1-20 Hex Bolts  
(2) M6 Large Flat Washers  
(2) M6 Lock Washers  
**IMPORTANT: TORQUE FOR 6MM FASTNERS MUST LESS THAN 6-7 FT-LBS OR THE FASTNERS WILL BE DAMAGED!**



(Fig 13) Step Bar Installed on Bracket Installed (Example)

### Attention

Do periodic inspections to the installation to make sure that all hardware is secure and tight. In order to protect your bars/boards, please use only mild soap/non-abrasive products for cleaning.