

iBoard®

iBoard® by APS

PART#: IB-065

READ INSTRUCTIONS CAREFULLY BEFORE STARTING INSTALLATION. REMOVE CONTENTS FROM BOX AND VERIFY ALL PARTS ARE PRESENT. ASSISTANCE IS RECOMMENDED.

*BODY FRAME MOUNT
*NO DRILLING REQUIRED

Fastener Size	Tightening Torque (ft-lbs)	Required
6mm	6-7	√
8mm	16-18	X
10mm	31-32	X
12mm	56-58	√
14mm	92-94	X

PART LIST

Front



Driver Front Mounting Bracket (DFM)

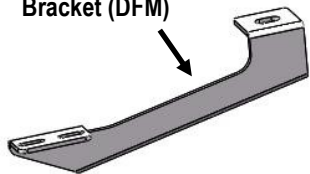

Passenger Front Mounting Bracket (PFM)

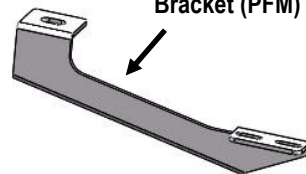

Driver Center Mounting Bracket (DCM)

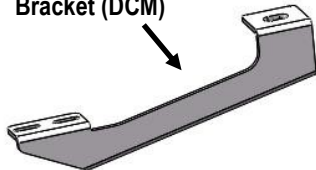

Passenger Center Mounting Bracket (PCM)

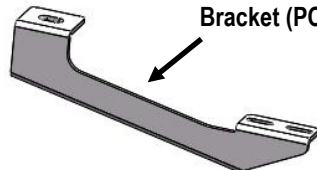

Driver Rear Mounting Bracket (DRM)

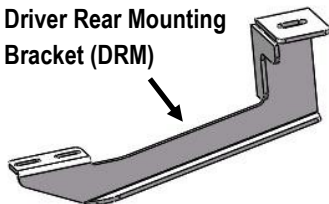

Passenger Rear Mounting Bracket (PRM)

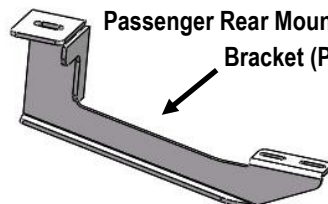

Customer Support: info@iboardauto.com

iBoard®

Hardware Package A (For Bracket Installation)



X6

M12X1.75-120mm Hex Bolt



X6

M12 Flat Washer



X6

M12 Lock Washer

Hardware Package B (For Aluminum Step Bar Installation Only, Not Supply to Stainless Steel Step Bar)

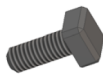

X12

M6X1-20mm Square Head Bolt



X12

M6 Large Flat Washer



X12

M6X1 Nylon Lock Nut

Hardware Package C (For Stainless Steel Step Bar Installation Only, Not Supply to Aluminum Step Bar)

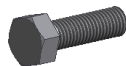

X12

M6X1-20mm Hex Bolt



X12

M6 Lock Washer



X12

M6 Flat Washer

STEP 1

Start installation from the passenger side of the vehicle. Remove the body mount bolts from body mounts.

Select the Passenger Front Mounting Bracket (**PFM**), Passenger Center Mounting Bracket (**PCM**) and Passenger Rear Mounting Bracket (**PRM**). Bolt the (3) mounting brackets to the vehicle with (3) M12X1.75-120mm Hex Bolts, (3) M12 Lock Washers and (3) M12 Flat Washers (**Fig 1**). Do not fully tighten hardware at this time.

STEP 2

Once all (3) mounting brackets are installed, then proceed to the Step Bar installation. According to the style of Step Bar proceed to the correct installation STEPS.

Note: Aluminum Step Bar refer to STEP 3; Stainless Steel Step Bar skip to STEP 4.

iBoard®

(Fig 1) Passenger Side Mounting Brackets Installation

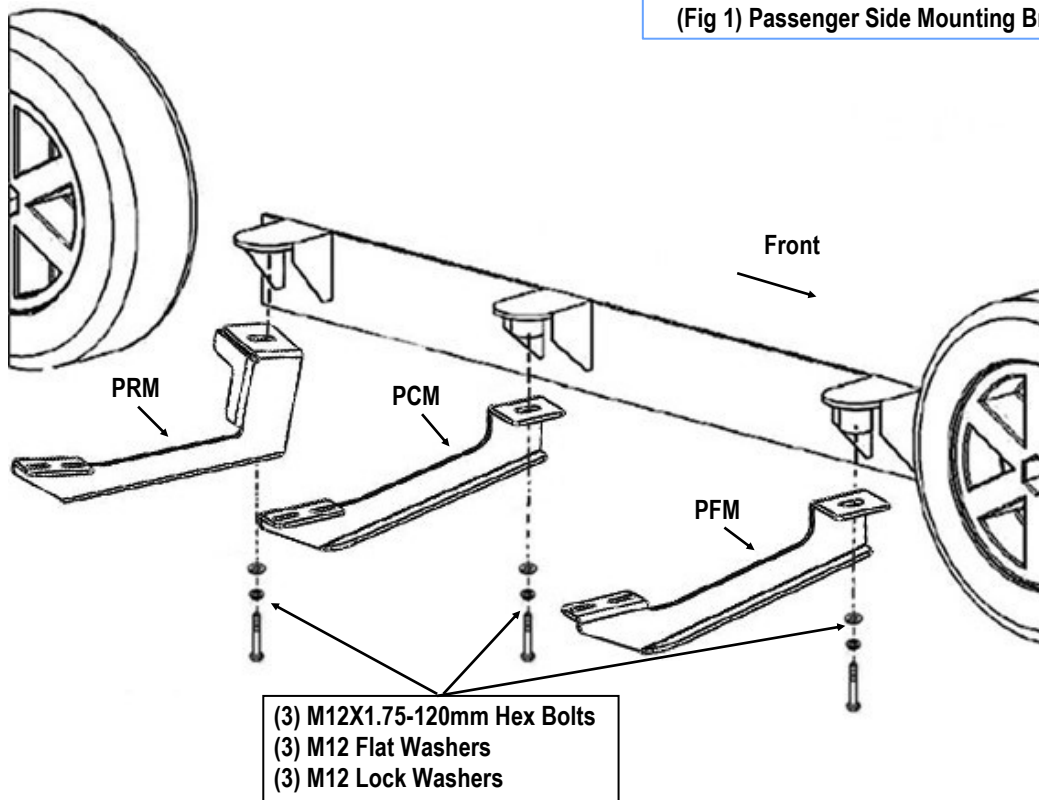

STEP 3

Aluminum Step Bar Installation:

Select a **Aluminum Step Bar**. Slip (3) M6x1-20mm Square Head Bolts into each bottom channel (Fig 2). Carefully position the Step Bar onto the (3) Mounting Brackets.

IMPORTANT: Do not slide the Step Bar on the Brackets or the bottom surface of the board will be damaged. Attach the Step Bar to each Mounting Brackets with (2) M6x1-20mm Square Head Bolts, (2) M6 Large Flat Washers and (2) M6X1 Nylon Lock Nuts, (Fig 3). Do not fully tighten at this time.

Level and adjust the Step Bar and fully tighten all hardware.

Repeat **Steps 1-3** for the other side Step Bar installation. **The installation is completed!!!**



(Fig 2) Slip M6X1-20mm Square Head Bolts Into The Bottom Channels

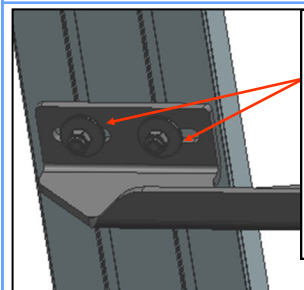

(2) M6X1-20mm Square Head Bolts
(2) M6 Large Flat Washers
(2) M6X1 Nylon Lock Nuts
IMPORTANT: TORQUE FOR 6MM FASTNERS MUST LESS THAN 6 -7 FT-LBS OR THE FASTNERS WILL BE DAMAGED!

(Fig 3) Running Board Installed Onto Mounting Bracket

iBoard®

STEP 4

Stainless Steel Step Bar Installation:

Select a **Stainless Steel Step Bar** (with the U-Sliders installed on the Bar). Loose the U-Sliders, reposition the U-Sliders onto the board according to the (3) Installed Mounting Brackets location, **(Fig 4)**. Re-secure the U-Sliders on the Step Bar. Attach the Step Bar to the installed Mounting Brackets with (6) M6X1-20mm Hex Bolts, (6) M6 Large Flat Washers & (6) M6 Lock Washers, **(Fig 5)**. Do not fully tighten hardware at this time.

Level and adjust the Step Bar and fully tighten all hardware.

Repeat **Steps 1-2 and 4** for the other side Step Bar installation.

The installation is completed!!!



(Fig 4) Slide & line up the U-Slider with the installed mounting brackets along bottom channel

- (2) M6X1-20mm Hex Bolts
- (2) M6 Large Flat Washers
- (2) M6 Lock Washers

IMPORTANT: TORQUE FOR 6MM FASTNERS MUST LESS THAN 6-7 FT-LBS OR THE FASTNERS WILL BE DAMAGED!

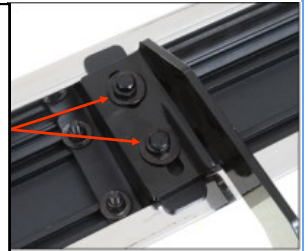

(Fig 5) Step Bar Installed on Bracket Installed (Example)

Attention

Do periodic inspections to the installation to make sure that all hardware is secure and tight.

In order to protect your bars/boards, please use only mild soap/non-abrasive products for cleaning.