

iBoard®

iBoard® by APS

PART#: IB-003/011/003S

READ INSTRUCTIONS CAREFULLY BEFORE STARTING INSTALLATION. REMOVE CONTENTS FROM BOX AND VERIFY ALL PARTS ARE PRESENT. ASSISTANCE IS RECOMMENDED.

*ROCKER PANEL MOUNT
*NO DRILLING REQUIRED

Fastener Size	Tightening Torque (ft-lbs)	Required
6mm	6-7	√
8mm	16-18	X
10mm	31-32	√
12mm	56-58	X
14mm	92-94	X

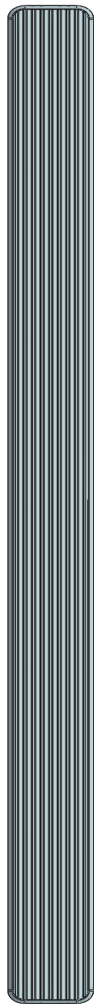

Driver Side Step Bar

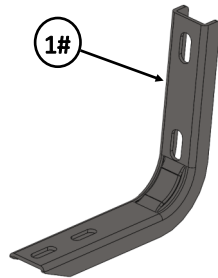

1#

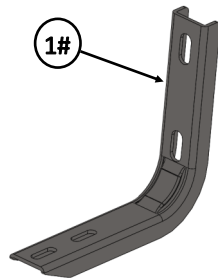

1#

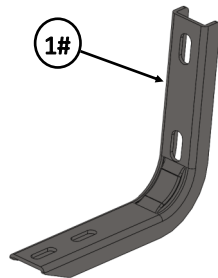

1#

Front
↑

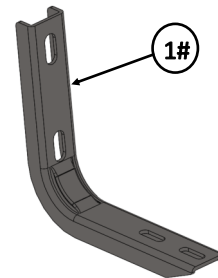

1#

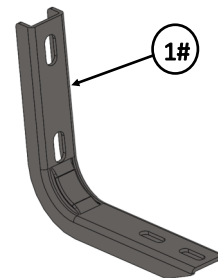

1#

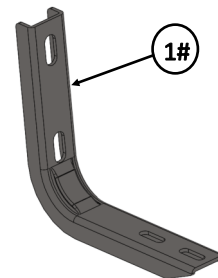

1#





Passenger Side Step Bar

iBoard®

Mounting Bracket List					
Item	QTY	Description	Item	QTY	Description
1#	6	Mounting Brackets			

Hardware Package A (For Bracket Installation)					
Item	QTY	Description	Item	QTY	Description
1#	12	M10X1.5-30mm Hex Bolts	4#	6	M10X1.5 Hex Nuts
2#	18	M10 Flat Washers	5#	6	M10 Clip Nuts
3#	12	M10 Lock Washers			

 1#

 2#

 3#

 4#

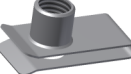
 5#

Hardware Package B (For Aluminum Step Bar Installation Only, Not Supply to SS. Step Bar)					
Item	QTY	Description	Item	QTY	Description
1#	12	M6X1-20mm Square Head Bolts	3#	12	M6X1 Nylon Lock Nuts
2#	12	M6 Large Flat Washers			

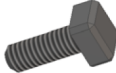
 1#

 2#

 3#

Hardware Package C (For Stainless Steel Step Bar Installation Only, Not Supply to Aluminum Step Bar)					
Item	QTY	Description	Item	QTY	Description
1#	12	M6X1-20mm Hex Bolts	3#	12	M6 Flat Washers
2#	12	M6 Lock Washers			

 1#

 2#

 3#

iBoard®

STEP 1

Starting on the driver side front of the vehicle. Locate the (3) mounting locations along the bottom of the body, (pinch weld), (Figs 1-2). Each mounting location on the inner body panel is comprised of a rectangular hole with a round hole on each side directly above each pair of holes in the pinch weld.

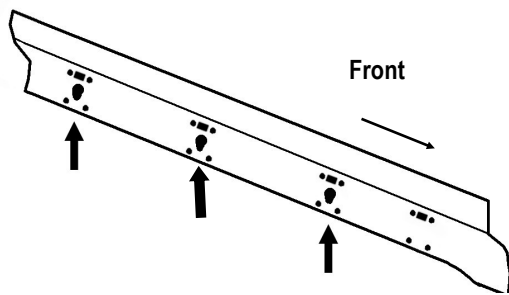

(Fig 1) Driver Side Mounting Locations (Illustrated Back View of Rocker Panel)

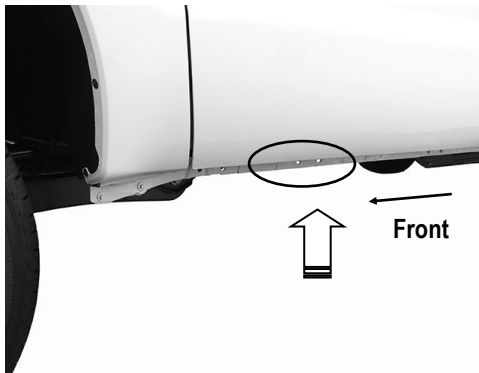

(Fig 2) The Mounting Holes on the Pinch Weld

STEP 2

Select (1) M10 Clip Nut. Insert the Clip Nut into the rectangular opening. Line up the threaded hole on the Clip Nut with the round hole beside the rectangular opening, (Fig 3).

NOTE: Make sure the threaded nut on Clip Nut must toward the inner side of the rocker panel, (Fig 3).

Line Up Clip Nuts With Factory Round Hole

Factory Hole In Pinch Weld Pictured From Behind Body Panel

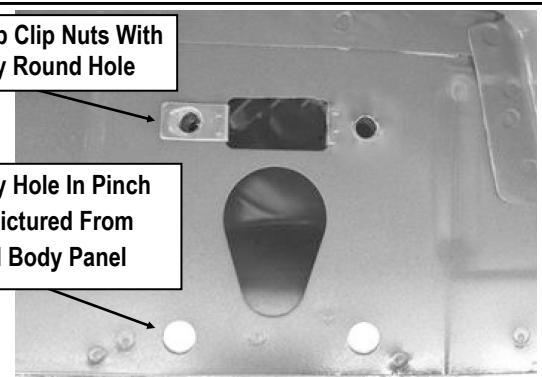

(Fig 3) M10 Clip Nut Installed

STEP 3

Partially attach the Driver Front Mounting Bracket to the M10 Clip Nut with the included (1) M10X1.5-30mm Hex Bolt, (1) M10 Lock Washer and (1) M10 Flat Washer, (Fig 4). Bolt the (1) lower hole on the Mounting Bracket to the (1) hole in the pinch weld with the included (1) M10X1.5-30mm Hex Bolt, (2) M10 Flat Washers, (1) M10 Lock Washer and (1) M10X1.5 Hex Nut, (Fig 4). Do not fully tighten hardware at this time.

(1) M10X1.5-30mm Hex Bolt
(1) M10 Flat Washer
(1) M10 Lock Washer

(1) M10X1.5-30mm Hex Bolt
(2) M10 Flat Washers
(1) M10 Lock Washer
(1) M10X1.5 Hex Nut

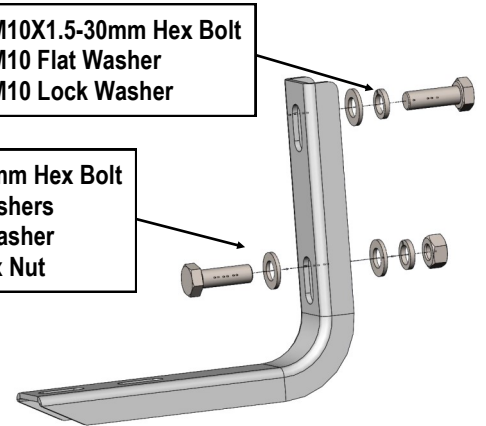

(Fig 4) Driver Front Mounting Bracket Installation Pictured

STEP 4

Move along the vehicle to the driver side center & rear mounting location. Repeat Steps 1-3 to install the Driver Center & Rear Mounting Bracket.

Note: (6) Mounting Brackets Are Universal.

iBoard®

STEP 5

Once all (3) mounting brackets are installed, then proceed to the Step Bar installation. According to the style of Step Bar proceed to the correct installation STEPS.

Note: Aluminum Step Bar refer to 6; Stainless Steel Step Bar skip to STEP 7.

STEP 6

Aluminum Step Bar Installation:

Select a **Aluminum Step Bar**. Slip (3) M6x1-20mm Square Head Bolts into each bottom channel (**Fig 5**). Carefully position the Step Bar onto the (3) Mounting Brackets.

IMPORTANT: Do not slide the Step Bar on the Brackets or the bottom surface of the board will be damaged. Attach the Step Bar to each Mounting Brackets with (2) M6x1-20mm Square Head Bolts, (2) M6 Large Flat Washers and (2) M6X1 Nylon Lock Nuts, (**Fig 6**). Do not fully tighten at this time.

Level and adjust the Step Bar and fully tighten all hardware. Repeat **Steps 1-6** for the other side Step Bar installation. **The installation is completed!!!**



(Fig 5) Slip M6X1-20mm Square Head Bolts Into The Bottom Channels

(2) M6X1-20mm Square Head Bolts
(2) M6 Large Flat Washers
(2) M6X1 Nylon Lock Nuts
IMPORTANT: TORQUE FOR 6MM FASTNERS MUST LESS THAN 6-7 FT-LBS OR THE FASTNERS WILL BE DAMAGED!

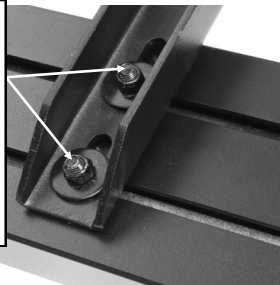

(Fig 6) Step Bar Installed Onto Mounting Bracket

STEP 7

Stainless Steel Step Bar Installation:

Select a **Stainless Steel Step Bar** (with the U-Sliders installed on the Bar). Loose the U-Sliders, reposition the U-Sliders onto the board according to the (3) Installed Mounting Brackets location, (**Fig 7**). Re-secure the U-Sliders on the Step Bar. Attach the Step Bar to the installed Mounting Brackets with (6) M6X1-20mm Hex Bolts, (6) M6 Large Flat Washers & (6) M6 Lock Washers, (**Fig 8**). Do not fully tighten hardware at this time. Level and adjust the Step Bar and fully tighten all hardware. Repeat **Steps 1-5 and 7** for the other side Step Bar installation. **The installation is completed!!!**

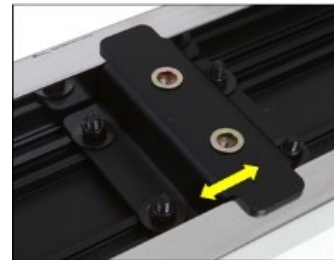

(Fig 7) Slide & line up the U-Slider with the installed mounting brackets along bottom channel

(2) M6X1-20mm Hex Bolts
(2) M6 Large Flat Washers
(2) M6 Lock Washers

IMPORTANT: TORQUE FOR 6MM FASTNERS MUST LESS THAN 6-7 FT-LBS OR THE FASTNERS WILL BE DAMAGED!

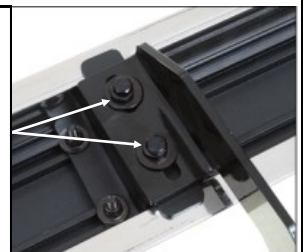

(Fig 8) Step Bar Installed on Bracket Installed (Example)

Attention

Do periodic inspections to the installation to make sure that all hardware is secure and tight.

In order to protect your bars/boards, please use only mild soap/non-abrasive products for cleaning.