

iBoard®

iBoard® by APS

PART#: IB-214

READ INSTRUCTIONS CAREFULLY BEFORE STARTING INSTALLATION. REMOVE CONTENTS FROM BOX AND VERIFY ALL PARTS ARE PRESENT. ASSISTANCE IS RECOMMENDED.

*ROCKER PANEL MOUNT
*NO DRILLING REQUIRED

Fastener Size	Tightening Torque (ft-lbs)	Required
6mm	6-7	√
8mm	16-18	√
10mm	31-32	√
12mm	56-58	X
14mm	92-94	X

PART LIST

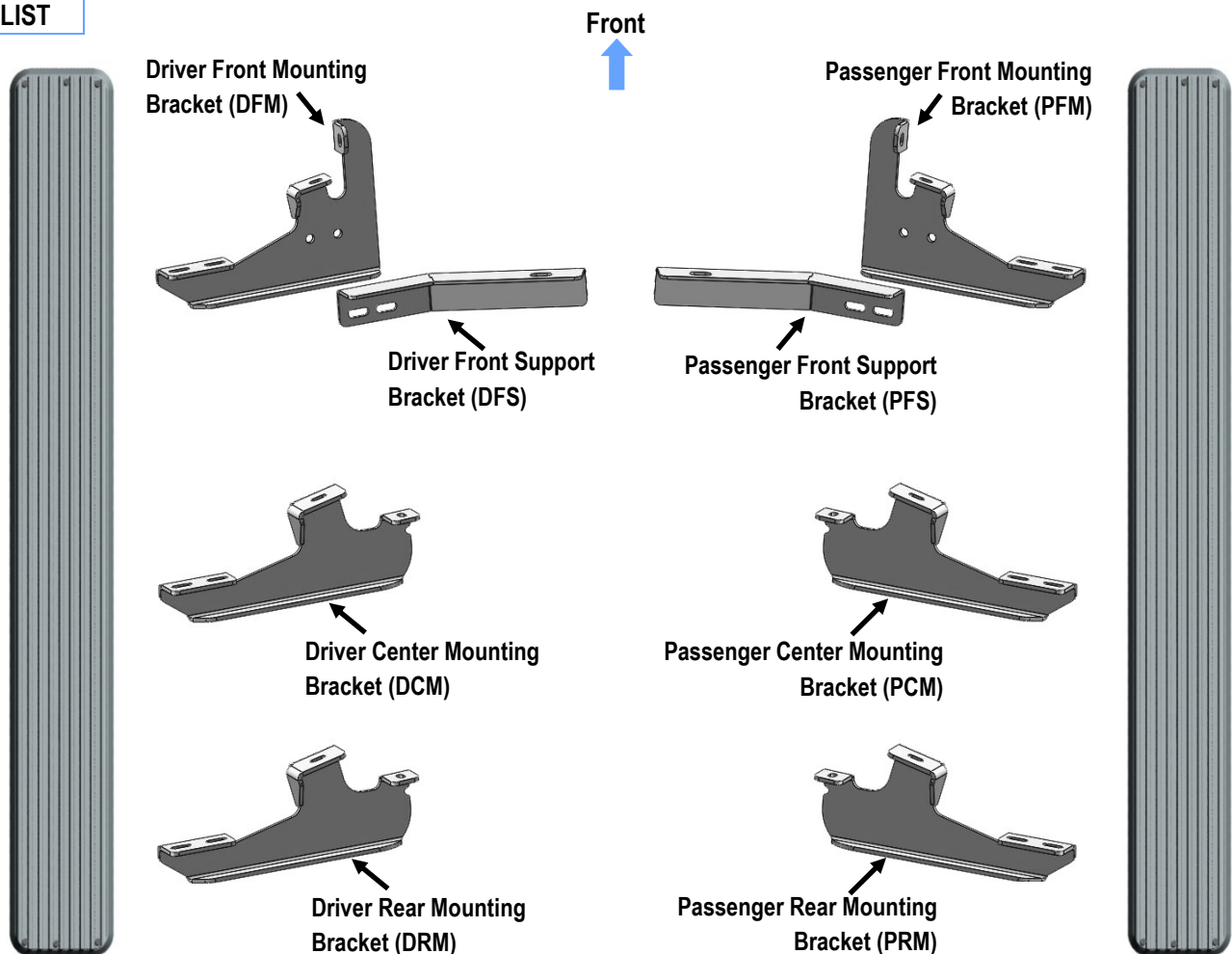

Customer Support: info@iboardauto.com

iBoard®

Hardware Package A (For Bracket Installation)

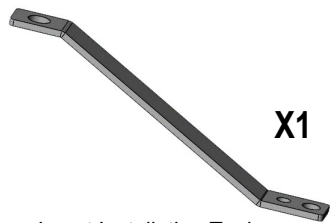

X1

Insert Installation Tool

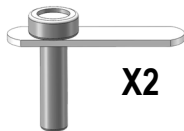

X2

M10X40 Bolt Plate



X2

M10 Flat Washer



X2

M10 Lock Washer

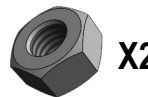

X2

M10 Hex Nut

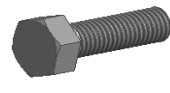

X4

M8X1.25-35mm Hex Bolt

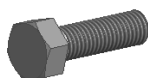

X12

M8X1.25-25mm Hex Bolt



X20

M8 Flat Washer



X16

M8 Lock Washer



X4

M8 Hex Nut



X2

M8 Rivet Nut

Hardware Package B (For Aluminum Step Bar Installation Only, Not Supply to Stainless Steel Step Bar)

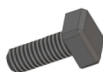

X12

M6X1-20mm Square Head Bolt



X12

M6 Large Flat Washer



X12

M6 Nylon Lock Nut

Hardware Package C (For Stainless Steel Step Bar Installation Only, Not Supply to Aluminum Step Bar)

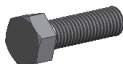

X12

M6X1-20mm Hex Bolt



X12

M6 Lock Washer



X12

M6 Flat Washer

STEP 1

Starting on the driver side front of the vehicle, locate the (2) factory 8mm threaded holes, one located in the bottom of the floor panel and the second in the side of the inner body panel, (Fig 1).

IMPORTANT: All factory threaded holes may be covered with rubber plugs or undercoating. Scrape off any excess undercoating from mounting surfaces.

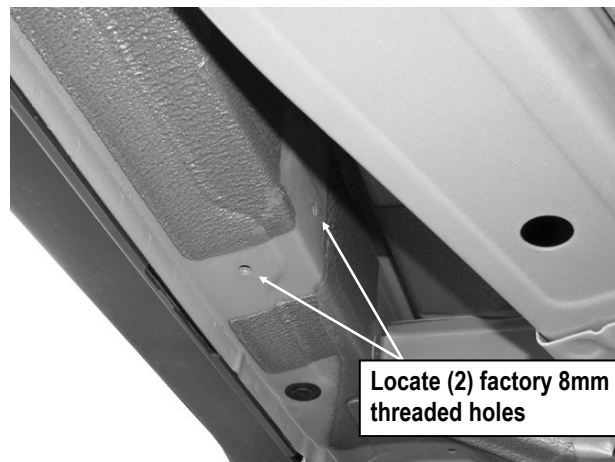

(Fig 1) Driver Side Front Mounting Location Pictured

iBoard®

STEP 2

Bolt the Driver Front Support Bracket (**DFS**) to the back of the Driver Front Mounting Bracket (**DFM**) with (2) M8X1.25-35mm Hex Bolts, (2) M8 Lock Washers, (2) M8 Hex Nuts and (4) M8 Flat Washers, (**Fig 2**). Do not fully tighten hardware at this time.

STEP 3

Select the Driver Front Mounting Bracket (**DFM**). Attach the Bracket to the (2) threaded holes using the provided (2) M8X1.25-25mm Hex Bolts, (2) M8 Lock Washers and (2) M8 Flat Washers, (**Fig 3**). Do not fully tighten hardware at this time.

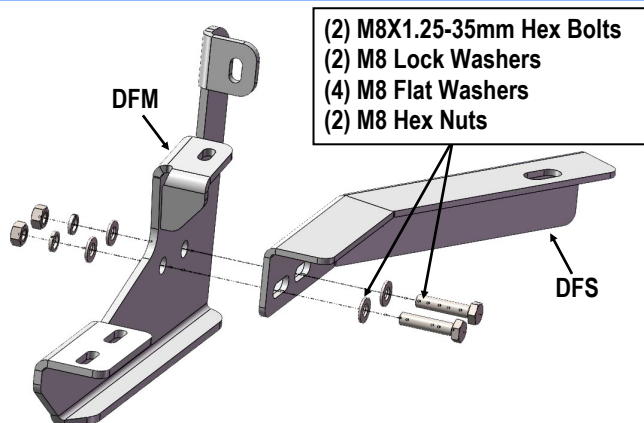

(Fig 2) Driver Side Front Brackets Assembly

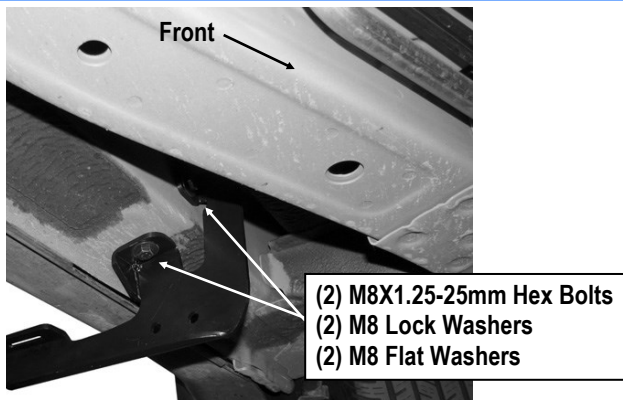

(Fig 3) Driver Side Front Mounting Bracket Installation

STEP 4

Select (1) M10 Bolt Plate. Insert the Bolt Plate into the factory hole in the bottom of the frame channel, (**Fig 4**). Rotate the Bolt Plate clock-wise 90-degrees or until it stops turning.

Next, hang the inner end of the Driver Front Support Bracket (**DFS**) from the previously installed M10 Bolt Plate using (1) M10 Flat Washer, (1) M10 Lock Washer and (1) M10 Hex Nut, (**Fig 5**). Do not fully tighten hardware at this time.

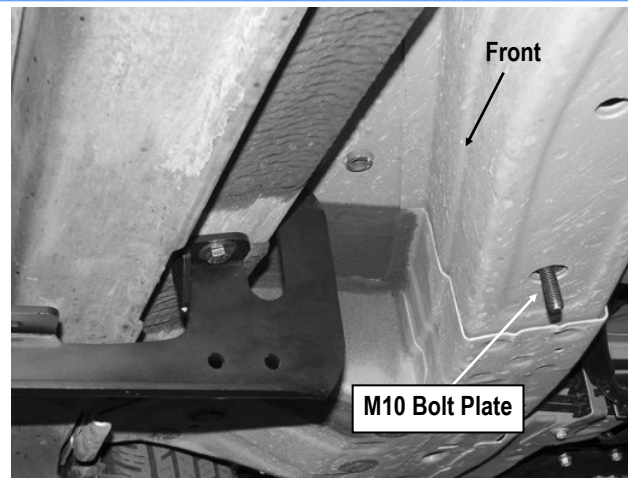

Fig 4

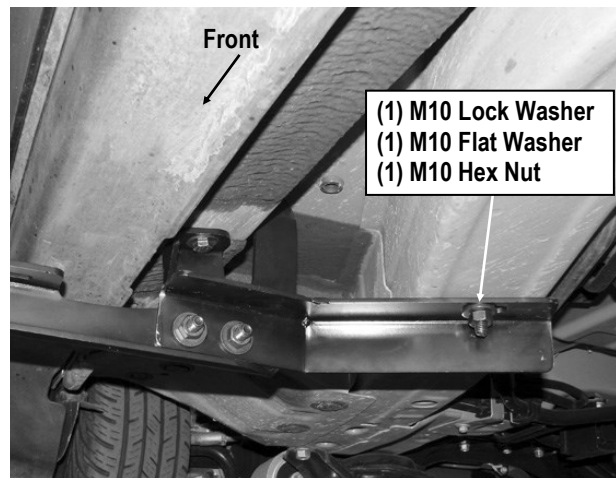

Fig 5

iBoard®

STEP 5

Next, move to the center of the vehicle and locate the (2) 8mm threaded holes located on the bottom of the floor panel and bottom of the frame channel, (**Fig 6**). Select the Driver Center Mounting Bracket (**DCM**). **IMPORTANT:** Center and Rear Brackets are similar but unique.

Attach the Center Bracket to the (2) threaded holes using the provided (2) M8X1.25-25mm Hex Bolts, (2) M8 Lock Washers and (2) M8 Flat Washers, (**Fig 7**). Do not fully tighten hardware at this time.

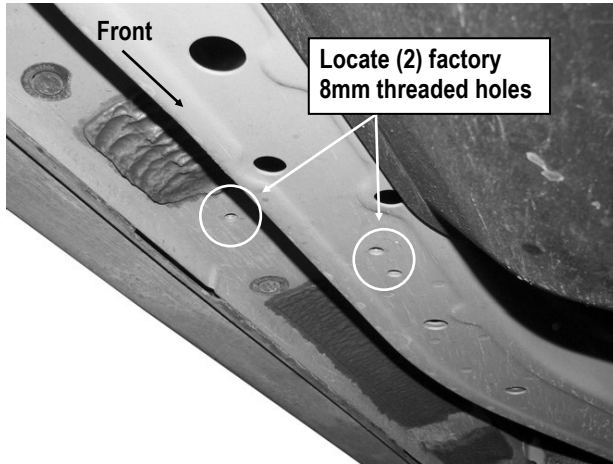

(Fig 6) Driver Side Center Mounting Location Pictured

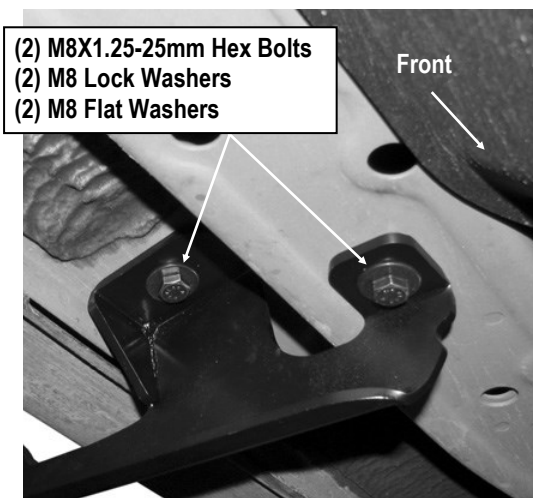

(Fig 7) Driver Side Center Mounting Bracket Installation

STEP 6

Continue along the side of the vehicle to the rear mounting location. Locate the 8mm threaded hole in the bottom of the frame channel, (**Fig 8**). Locate the factory hole in the bottom of the floor panel. Remove rubber plugs as necessary.

NOTE: To determine the correct mounting holes to use, hold the Driver Rear Mounting Bracket (**DRM**) up in position against the factory threaded hole in the end of the frame channel, (**Fig 8**). Remaining hole in mounting tab on the bracket will line up with correct factory hole in floor panel.

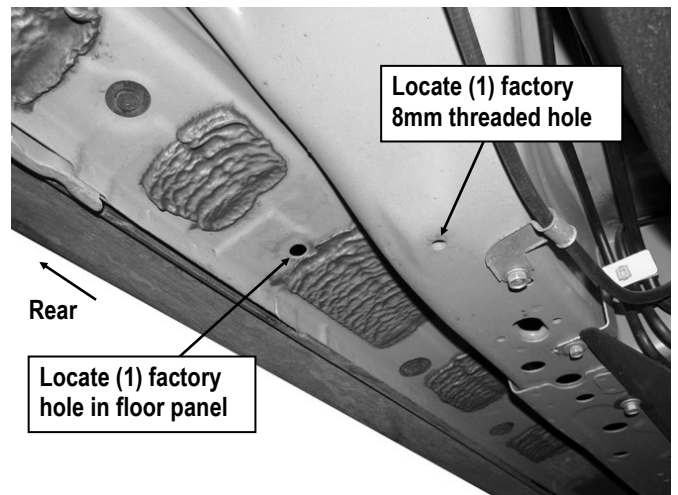

(Fig 8) Driver Side Rear Mounting Location Pictured

STEP 7

Select the Threaded Insert Tool, (1) M8 Rivet Nut, (1)M8 Flat Washer and (1) M8x1.25-25mm Hex Bolt, (**Fig 9**). Assemble the tool as pictured in **Fig 9**. **NOTE: Select 8mm hole on threaded tool (Fig 10).**

Insert the assembly into the factory hole. Firmly hold the tool handle and assembly up tight against the floor panel and tighten the M8 Hex Bolt until the insert is fully expanded in the hole, (**Fig 11**). **NOTE:** Do not over tighten or a pull out may occur. Once Insert is fully compressed, remove the bolt and tool from the Insert.

iBoard®

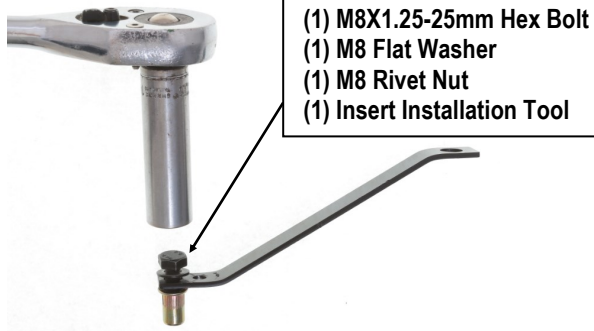

Fig 9



Fig 10



(Fig 11) Tighten Hex Bolt To Collapse And Lock Threaded Insert Into Factory Hole

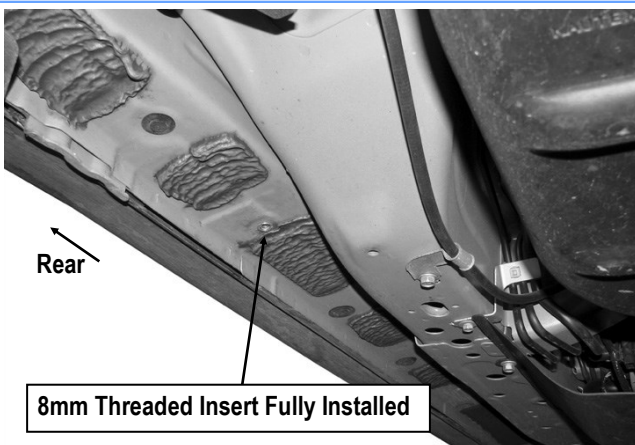
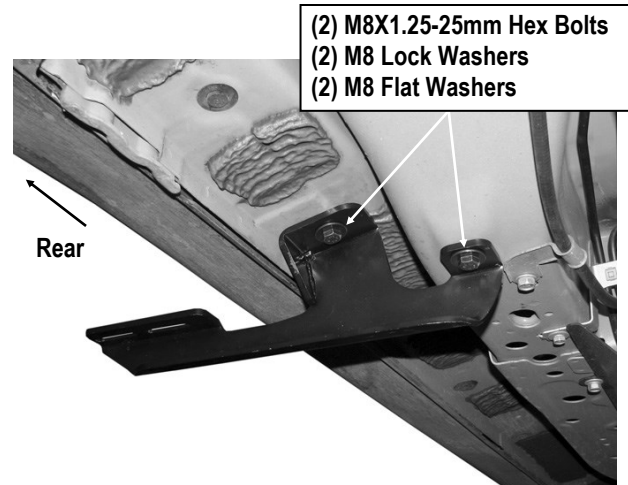

Fig 12

STEP 8

Repeat **Step 3** to attach the Driver Rear Mounting Bracket (DRM) to the (2) threaded holes, (Fig 13). Do not fully tighten hardware at this time.



(Fig 13) Driver Side Rear Mounting Bracket Installation

STEP 9

Once all (3) mounting brackets are installed, then proceed to the Step Bar installation. According to the style of Step Bar proceed to the correct installation STEPS.

Note: Aluminum Step Bar refer to STEP 10; Stainless Steel Step Bar skip to STEP 11.

iBoard®

STEP 10

Aluminum Step Bar Installation:

Select a **Aluminum Step Bar**. Slip (3) M6x1-20mm Square Head Bolts into each bottom channel (**Fig 14**). Carefully position the Step Bar onto the (3) Mounting Brackets.

IMPORTANT: Do not slide the Step Bar on the Brackets or the bottom surface of the board will be damaged. Attach the Step Bar to each Mounting Brackets with (2) M6x1-20mm Square Head Bolts, (2) M6 Large Flat Washers and (2) M6 Nylon Lock Nuts, (**Fig 15**). Do not fully tighten at this time.

Level and adjust the Step Bar and fully tighten all hardware. Repeat **Steps 1-10** for the other side Step Bar installation. **The installation is completed!!!**



(Fig 14) Slip M6X1-20mm Square Head Bolts Into The Bottom Channels

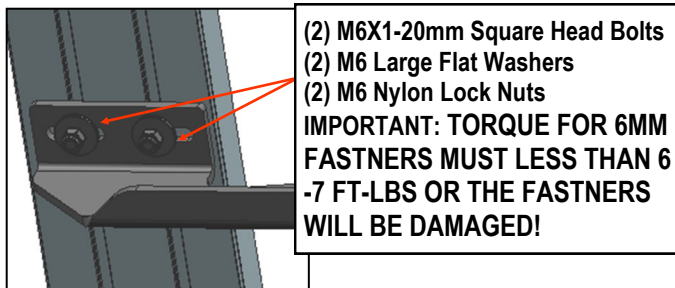

(Fig 15) Running Board Installed Onto Mounting Bracket

STEP 11

Stainless Steel Step Bar Installation:

Select a **Stainless Steel Step Bar** (with the U-Sliders installed on the Bar). Loose the U-Sliders, reposition the U-Sliders onto the board according to the (3) Installed Mounting Brackets location, (**Fig 16**). Re-secure the U-Sliders on the Step Bar. Attach the Step Bar to the installed Mounting Brackets with (6) M6X1-20mm Hex Bolts, (6) M6 Large Flat Washers & (6) M6 Lock Washers, (**Fig 17**). Do not fully tighten hardware at this time.

Level and adjust the Step Bar and fully tighten all hardware. Repeat **Steps 1-9 and 11** for the other side Step Bar installation. **The installation is completed!!!**

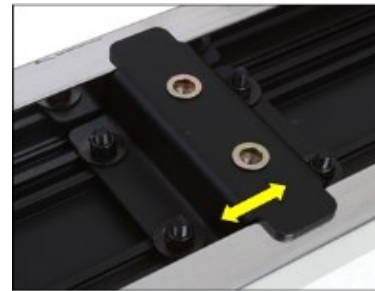

(Fig 16) Slide & line up the U-Slider with the installed mounting brackets along bottom channel

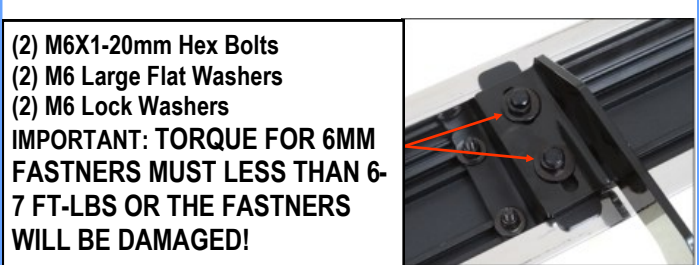

(Fig 17) Step Bar Installed on Bracket Installed (Example)

Attention

Do periodic inspections to the installation to make sure that all hardware is secure and tight. In order to protect your bars/boards, please use only mild soap/non-abrasive products for cleaning.