

iBoard®

iBoard® by APS

PART#: IB-062

READ INSTRUCTIONS CAREFULLY BEFORE STARTING INSTALLATION. REMOVE CONTENTS FROM BOX AND VERIFY ALL PARTS ARE PRESENT. ASSISTANCE IS RECOMMENDED.

*ROCKER PANEL MOUNT
*NO DRILLING REQUIRED

Fastener Size	Tightening Torque (ft-lbs)	Required
6mm	6-7	√
8mm	16-18	√
10mm	31-32	X
12mm	56-58	X
14mm	92-94	X

PART LIST

Front

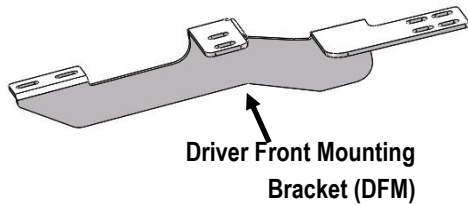

Driver Front Mounting Bracket (DFM)

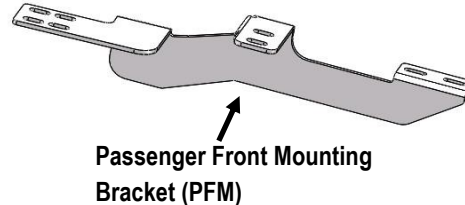

Passenger Front Mounting Bracket (PFM)

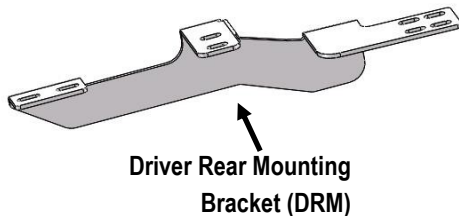

Driver Rear Mounting Bracket (DRM)

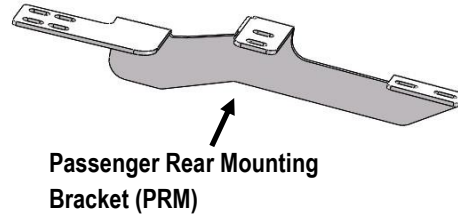

Passenger Rear Mounting Bracket (PRM)



Customer Support: info@iboardauto.com

iBoard®

Hardware Package A (For Bracket Installation)



Hardware Package B (For Aluminum Step Bar Installation Only, Not Supply to Stainless Steel Step Bar)

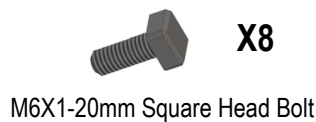

Hardware Package C (For Stainless Steel Step Bar Installation Only, Not Supply to Aluminum Step Bar)



STEP 1

Start installation from the driver side front of the vehicle. From underneath vehicle, place driver side front bracket in position as shown in **(Fig 1)**.



STEP 2

Attach Driver Front Mounting Bracket (**DFM**) to location with (6) M8x1.25-35mm Hex Bolts, (6) M8 Flat Washers, (6) M8 Lock Washers, (6) M8 Hex Nuts, **(Fig 3)**. Do not fully tighten at this time.
Repeat for Driver Rear Mounting Bracket (**DRM**) installation.

STEP 3

Once all (2) mounting brackets are installed, then proceed to the Step Bar installation. According to the style of Step Bar proceed to the correct installation STEPS.

Note: Aluminum Step Bar refer to **STEP 4**; Stainless Steel Step Bar skip to **STEP 5**.

iBoard®

- (6) M8x1.25-35mm Hex Bolts
- (6) M8 Flat Washers
- (6) M8 Lock Washers
- (6) M8 Hex Nuts

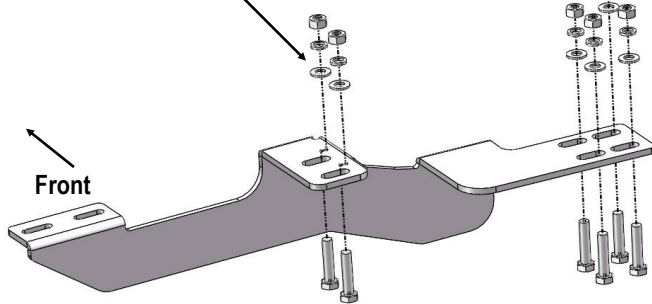

(Fig 2) Driver Front Mounting Bracket Installation

STEP 4

Aluminum Step Bar Installation:

Select a **Aluminum Step Bar**. Slip (2) M6x1-20mm Square Head Bolts into each bottom channel (Fig 3). Carefully position the Step Bar onto the (2) Mounting Brackets.

IMPORTANT: Do not slide the Step Bar on the Brackets or the bottom surface of the board will be damaged. Attach the Step Bar to each Mounting Brackets with (2) M6x1-20mm Square Head Bolts, (2) M6 Large Flat Washers and (2) M6 Nylon Lock Nuts, (Fig 4). Do not fully tighten at this time.

Level and adjust the Step Bar and fully tighten all hardware. Repeat **Steps 1-4** for the other side Step Bar installation. **The installation is completed!!!**



(Fig 3) Slip M6X1-20mm Square Head Bolts Into The Bottom Channels

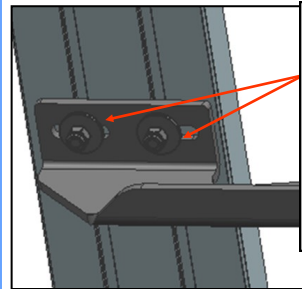

- (2) M6X1-20mm Square Head Bolts
 - (2) M6 Large Flat Washers
 - (2) M6 Nylon Lock Nuts
- IMPORTANT: TORQUE FOR 6MM FASTNERS MUST LESS THAN 6-7 FT-LBS OR THE FASTNERS WILL BE DAMAGED!**

(Fig 4) Running Board Installed Onto Mounting Bracket

STEP 5

Stainless Steel Step Bar Installation:

Select a **Stainless Steel Step Bar** (with the U-Sliders installed on the Bar). Loose the U-Sliders, reposition the U-Sliders onto the board according to the (2) Installed Mounting Brackets location, (Fig 5). Re-secure the U-Sliders on the Step Bar. Attach the Step Bar to the installed Mounting Brackets with (4) M6X1-20mm Hex Bolts, (4) M6 Large Flat Washers & (4) M6 Lock Washers, (Fig 6). Do not fully tighten hardware at this time.

Level and adjust the Step Bar and fully tighten all hardware. Repeat **Steps 1-3 and 5** for the other side Step Bar installation. **The installation is completed!!!**



(Fig 5) Slide & line up the U-Slider with the installed mounting brackets along bottom channel

iBoard®

(2) M6X1-20mm Hex Bolts
(2) M6 Large Flat Washers
(2) M6 Lock Washers
**IMPORTANT: TORQUE FOR 6MM
FASTNERS MUST LESS THAN 6-
7 FT-LBS OR THE FASTNERS
WILL BE DAMAGED!**

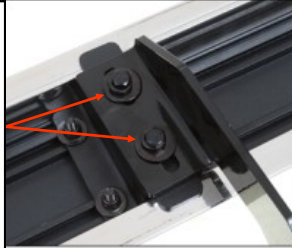

(Fig 6) Step Bar Installed on Bracket Installed (Example)

Attention

Do periodic inspections to the installation to make sure that all hardware is secure and tight.

In order to protect your bars/boards, please use only mild soap/non-abrasive products for cleaning.