

iBoard®

iBoard® by APS

PART#: IB-228

READ INSTRUCTIONS CAREFULLY BEFORE STARTING INSTALLATION. REMOVE CONTENTS FROM BOX AND VERIFY ALL PARTS ARE PRESENT. ASSISTANCE IS RECOMMENDED.

*ROCKER PANEL MOUNT
*NO DRILLING REQUIRED

Fastener Size	Tightening Torque (ft-lbs)	Required
6mm	6-7	√
8mm	16-18	√
10mm	31-32	X
12mm	56-58	X
14mm	92-94	X

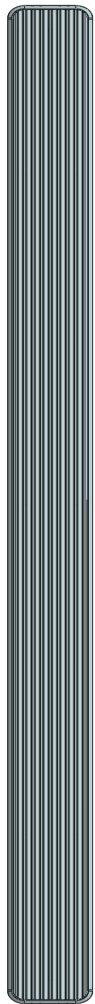

Driver Side Step Bar

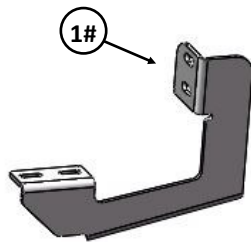
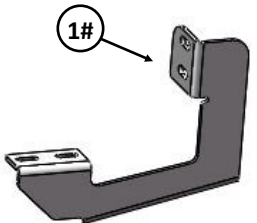
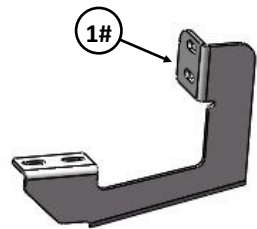

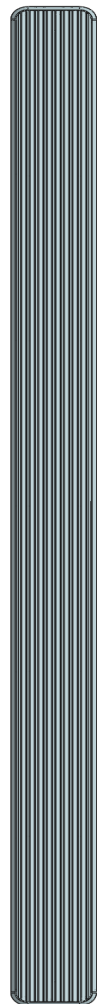
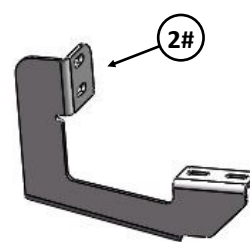
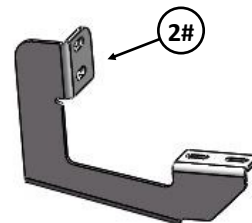
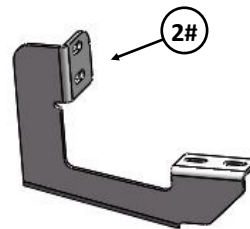

Front
↑







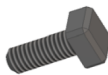

Passenger Side Step Bar

iBoard®

Mounting Bracket List					
Item	QTY	Description	Item	QTY	Description
1#	3	Driver Front/Center/Rear Mounting Brackets	2#	3	Passenger Front/Center/Rear Mounting Brackets

Hardware Package A (For Bracket Installation)					
Item	QTY	Description	Item	QTY	Description
1#	12	M8 Large Flat Washers	2#	12	M8X1.25 Nylon Lock Nuts
		 1#	 2#		

Hardware Package B (For Aluminum Step Bar Installation Only, Not Supply to SS. Step Bar)					
Item	QTY	Description	Item	QTY	Description
1#	12	M6X1-20mm Square Head Bolts	3#	12	M6X1 Nylon Lock Nuts
2#	12	M6 Large Flat Washers			
		 1 #	 2 #	 3#	

Hardware Package C (For Stainless Steel Step Bar Installation Only, Not Supply to Aluminum Step Bar)					
Item	QTY	Description	Item	QTY	Description
1#	12	M6X1-20mm Hex Bolts	3#	12	M6 Flat Washers
2#	12	M6 Lock Washers			
		 1 #	 2 #	 3 #	

iBoard®

STEP 1

Start installation from the driver side front of the vehicle. Locate the (2) factory threaded studs located on the side of the inner body panel, (Fig 1).

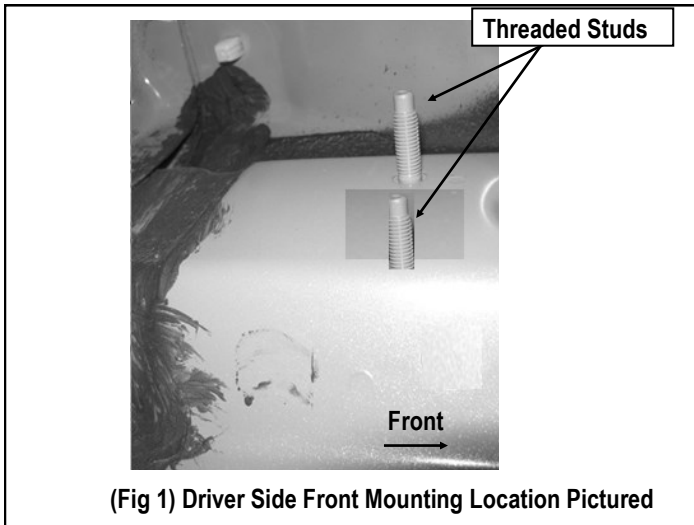

STEP 2

Select the Driver Front Mounting Bracket. Attach to the (2) factory threaded studs with (2) M8 Large Flat Washers and (2) M8X1.25 Nylon Lock Nuts, (Fig 2). Do not fully tighten hardware at this time.

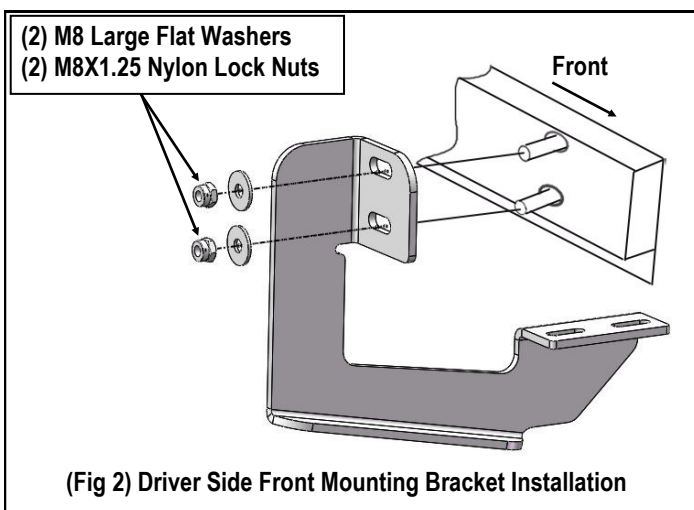

STEP 3

Move to the center & rear mounting location. Repeat **Steps 1 – 2** for Driver Center & Rear Mounting Brackets.

Note: (3) Driver Side Mounting Brackets are universal.

STEP 4

Once all (3) mounting brackets are installed, then proceed to the Step Bar installation. According to the style of Step Bar proceed to the correct installation STEPS.

Note: Aluminum Step Bar refer to **STEP 5**; Stainless Steel Step Bar skip to **STEP 6**.

STEP 5

Aluminum Step Bar Installation:

Select a **Aluminum Step Bar**. Slip (3) M6x1-20mm Square Head Bolts into each bottom channel (Fig 3). Carefully position the Step Bar onto the (3) Mounting Brackets.

IMPORTANT: Do not slide the Step Bar on the Brackets or the bottom surface of the board will be damaged. Attach the Step Bar to each Mounting Brackets with (2) M6x1-20mm Square Head Bolts, (2) M6 Large Flat Washers and (2) M6x1 Nylon Lock Nuts, (Fig 4). Do not fully tighten at this time.

Level and adjust the Step Bar and fully tighten all hardware.

Repeat **Steps 1-5** for the other side Step Bar installation. **The installation is completed!!!**

iBoard®



(Fig 3) Slip M6X1-20mm Square Head Bolts Into The Bottom Channels



(Fig 5) Slide & line up the U-Slider with the installed mounting brackets along bottom channel

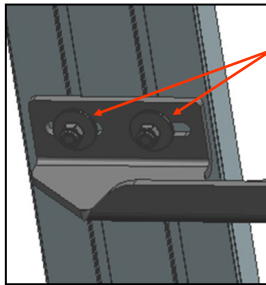

(2) M6X1-20mm Square Head Bolts
(2) M6 Large Flat Washers
(2) M6X1 Nylon Lock Nuts
IMPORTANT: TORQUE FOR 6MM FASTENERS MUST LESS THAN 6-7 FT-LBS OR THE FASTENERS WILL BE DAMAGED!

(Fig 4) Step Bar Installed Onto Mounting Bracket

(2) M6X1-20mm Hex Bolts
(2) M6 Large Flat Washers
(2) M6 Lock Washers
IMPORTANT: TORQUE FOR 6MM FASTENERS MUST LESS THAN 6-7 FT-LBS OR THE FASTENERS WILL BE DAMAGED!

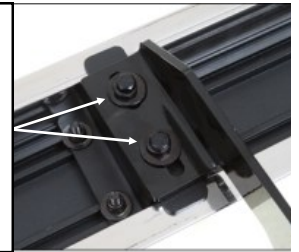

(Fig 6) Step Bar Installed on Bracket Installed

STEP 6

Stainless Steel Step Bar Installation:

Select a **Stainless Steel Step Bar** (with the U-Sliders installed on the Bar). Loose the U-Sliders, reposition the U-Sliders onto the board according to the (3) Installed Mounting Brackets location, (Fig 5). Re-secure the U-Sliders on the Step Bar. Attach the Step Bar to the installed Mounting Brackets with (6) M6X1-20mm Hex Bolts, (6) M6 Large Flat Washers & (6) M6 Lock Washers, (Fig 6). Do not fully tighten hardware at this time.

Level and adjust the Step Bar and fully tighten all hardware.

Repeat **Steps 1-4 and 6** for the other side Step Bar installation.
The installation is completed!!!

Attention

Do periodic inspections to the installation to make sure that all hardware is secure and tight.

In order to protect your bars/boards, please use only mild soap/non-abrasive products for cleaning.