

iBoard[®]

iBoard[®] by APS

PART#: IB-R049/R951

READ INSTRUCTIONS CAREFULLY BEFORE STARTING INSTALLATION. REMOVE CONTENTS FROM BOX AND VERIFY ALL PARTS ARE PRESENT. ASSISTANCE IS RECOMMENDED.

*ROCKER PANEL MOUNT
*NO DRILLING REQUIRED

Fastener Size	Tightening Torque (ft-lbs)	Required
6mm	6-7	√
8mm	16-18	√
10mm	31-32	X
12mm	56-58	X
14mm	92-94	X

Item	QTY	Description	Item	QTY	Description
1#	6	Mounting Brackets	5#	6	M8 Hex Flange Nuts
2#	12	M8X1.25-25mm Hex Bolts	6#	12	M6X1-20mm Square Head Bolts
3#	12	M8 Flat Washers	7#	12	M6 Large Flat Washers
4#	12	M8 Lock Washers	8#	12	M6 Nylon Lock Nuts

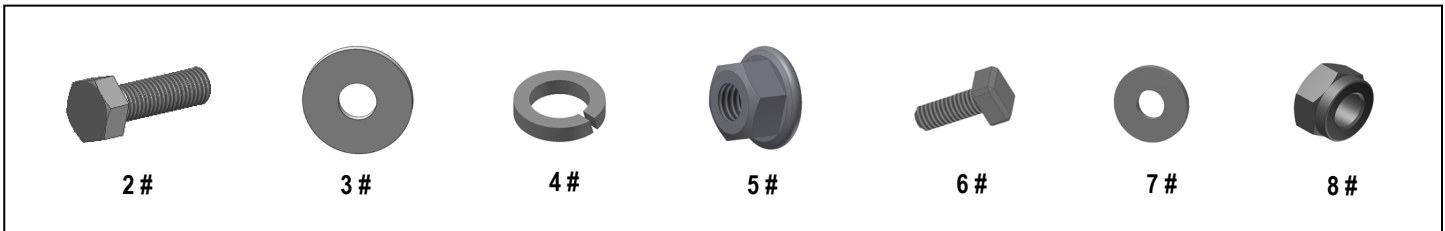

iBoard®

Driver

Front

Passenger

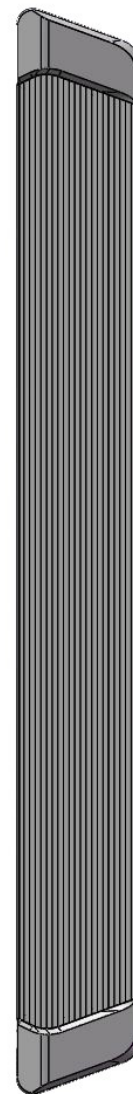
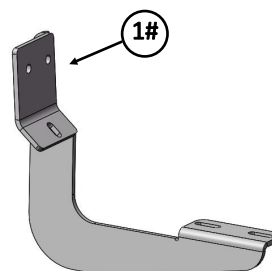
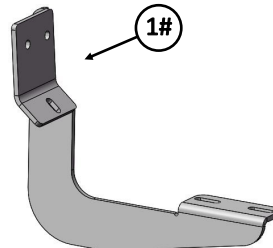
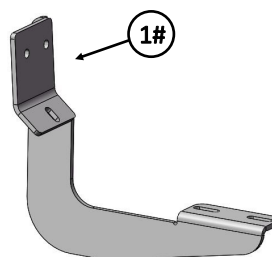
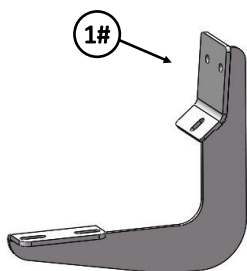
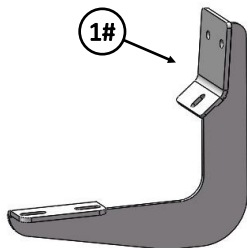
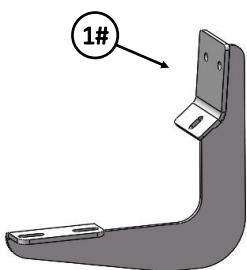

iBoard®

STEP 1

Start installation from the driver side front of the vehicle. Locate the factory threaded holes or stud located on the side of the inner body panel, (Figs 1 & 2). **NOTE:** Remove the plastic plug or any insulation on the side panel to locate the threaded holes.

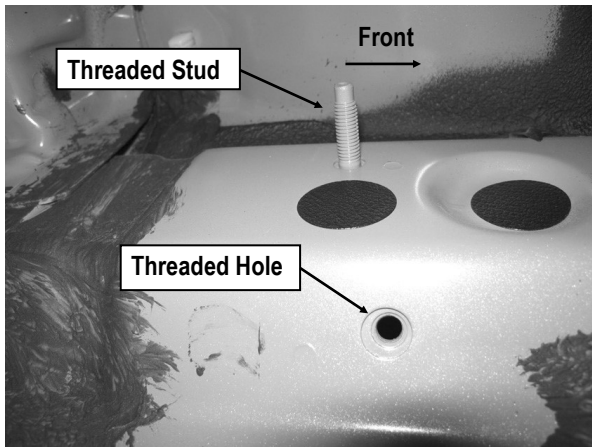

(Fig 1) Up To 2015 Driver Side Rear Mounting Location Pictured. (Note: Remove Plastic Plug To Locate Factory Threaded Hole)

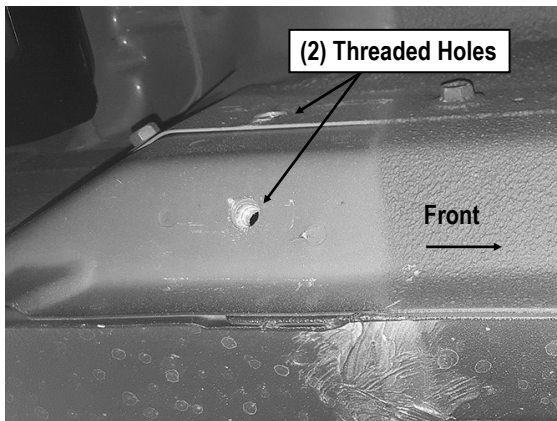

(Fig 2) 2016-On Driver Side Rear Mounting Location Pictured. (Note: (2) Factory Threaded Holes Only)

STEP 2

Attach (1) Mounting Bracket onto the Driver Side Front Mounting Location as shown.

- Models with threaded stud (Fig 3):** Attach the Mounting Bracket to stud with (1) M8 Nylon Lock Nut. Next, secure the bracket to the lower threaded hole with (1) M8X1.25-25mm Hex Bolt, (1) M8 Flat Washer and (1) M8 Lock Washer. Do not tighten hardware at this time.
- Models without threaded stud (Fig 4):** Attach the Mounting Bracket to the upper threaded hole with (1) M8X1.25-25mm Hex Bolt, (1) M8 Flat Washer and (1) M8 Lock Washer. Next, secure the bracket to the lower threaded hole with (1) M8X1.25-25mm Hex Bolt, (1) M8 Flat Washer and (1) M8 Lock Washer, (Fig 4). Do not fully tighten hardware at this time.

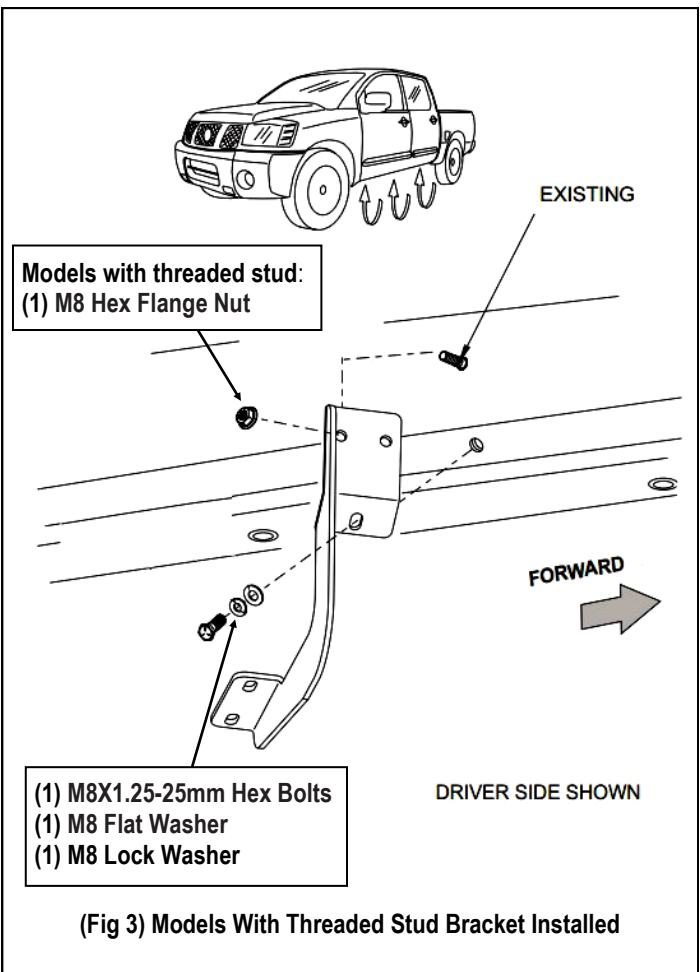

iBoard®

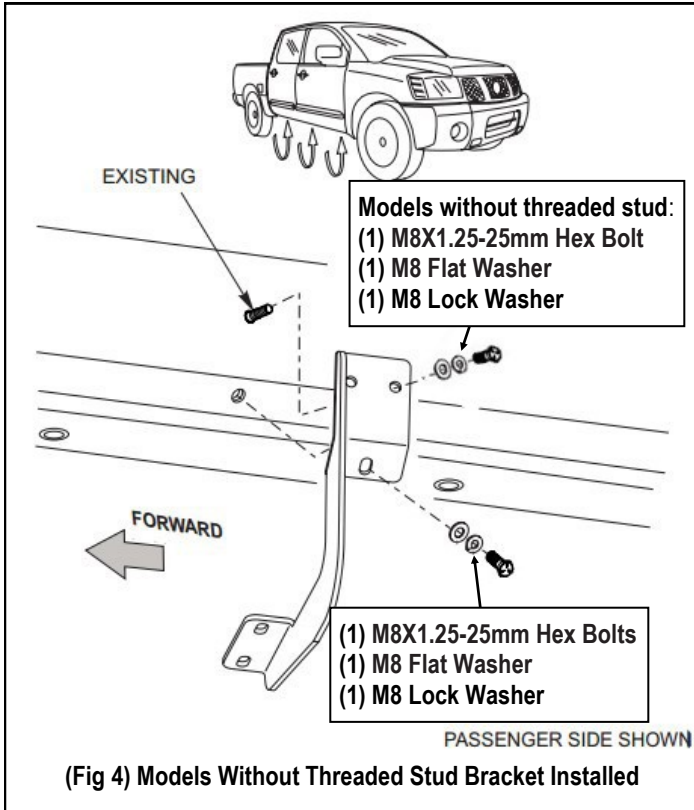

STEP 3

Move to the driver side center & rear Mounting Locations. Repeat **Steps 1-2** to install the driver side center and rear Brackets. Don't fully tighten the hardware at this time.

STEP 4

Select a Running Board. Slip (3) M6x1-20mm Square Head Bolts into each bottom channel (**Fig 5**). Carefully position the Running Board onto the (3) Mounting Brackets.

IMPORTANT: Do not slide the Running Board on the Brackets or the bottom surface of the board will be damaged. Attach the Running Board to each Mounting Bracket with (2) M6x1-20mm Square Head Bolts, (2) M6 Large Flat Washers and (2) M6 Nylon Lock Nuts, (**Fig 6**). Do not fully tighten at this time.

Level and adjust the Running Board and fully tighten all hardware.

M6X1-20mm Square Head Bolts

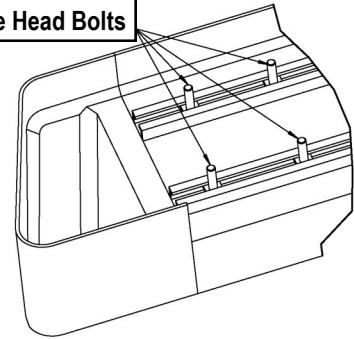

(Fig 5) Slip M6X1-20mm Square Head Bolts Into The Bottom Channels

(2) M6X1-20mm Square Head Bolts
(2) M6 Large Flat Washers
(2) M6 Nylon Lock Nuts

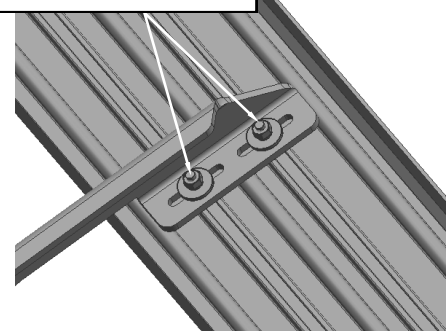

(Fig 6) Running Board Installed Onto Mounting Bracket

STEP 5

Repeat **Steps 1-4** for the other side Running Board installation. The installation is completed.

Attention

Do periodic inspections to the installation to make sure that all hardware is secure and tight.

In order to protect your bars/boards, please use only mild soap/non-abrasive products for cleaning.