



INSTALLATION INSTRUCTIONS

300 W PONTIAC WAY CLOVIS, CA 93612 local: 559-875-0222 fax: 559-876-2249 toll free: 800-445-3767

15001/16001 COILOVER 2015+ FORD F-150 2WD (-1" to -3.5")

Thank you for being selective enough to choose our high quality BELLTECH PRODUCT. We have spent many hours developing our line of products so that you will receive maximum performance with minimum difficulty during installation.

- Note: Confirm that all hardware listed in the parts list (page 6) is in the kit. **DO NOT** begin installation if any part is missing. Read the instructions thoroughly before beginning this installation.
- Warning:** **DO NOT** work under a vehicle supported by only a jack. Place support stands securely under the vehicle in the manufacturer's specified locations unless otherwise instructed.
- Warning:** **DO NOT** drive vehicle until all work has been completed and checked. Torque all hardware to values specified.
- Reminder: Proper use of safety equipment and eye/face/hand protection is necessary when using these tools to perform procedures!
- Note: It is very helpful to have an assistant available during installation.
- Note: Before making any adjustments to your new Belltech coilover, please be sure to loosen the set screw. Failure to do so will damage the threads. After the adjustments are made, you may then tighten the set screw to keep the settings in place.

RECOMMENDED TOOLS:

- Properly rated floor jack and support stands
- Wheel chocks
- Metric socket set up to 27mm
- Metric combination wrench set up to 27mm
- SAE combination wrench set up to $\frac{3}{4}$ "
- Torque wrench
- Ball Joint puller
- Die Grinder with carbide metal cutting bit
- Safety Glasses

JACKING, SUPPORTING AND PREPARING THE VEHICLE

- a) Block the rear wheels of the vehicle with appropriate wheel chocks. Make sure the vehicle's transmission is in "Park" (automatic) or 1st gear (manual). Activate the parking brake.
- b) Loosen, but **DO NOT REMOVE**, the front wheel lug nuts.
- c) Lift the front of the vehicle off the ground using a properly rated floor jack. Lift the vehicle so that the front tires are approximately 6-8 inches off the ground surface.
- d) Support the vehicle using support stands rated for the vehicle's weight. The stands should be positioned in the factory specified locations (refer to owner's manual). Prior to lowering the vehicle onto stands, make sure the supports will securely contact the chassis. It is very

important that the vehicle is properly supported during this installation to prevent frame damage and personal injury! Make sure that the support stands are properly placed prior to performing the following procedures.

- e) Lower the vehicle slowly onto the stands, checking that they properly and securely contact the frame rails as described above before placing the vehicles weight fully on them.
- f) Remove the front wheels from the vehicle.

SAFETY REMINDER: Check for safe vehicle stability before proceeding under the vehicle to begin the following procedures. Never work under a vehicle supported by only a jack. Always use properly rated support stands to support the vehicle.

1. REMOVING THE OEM STRUT

- 1a) Unbolt the brackets holding the brake and ABS lines from the spindle and the frame. Also remove the plastic clip holding the ABS line to the frame and brake line bracket. Be careful not to damage any of the lines. **(photo 1&2)**

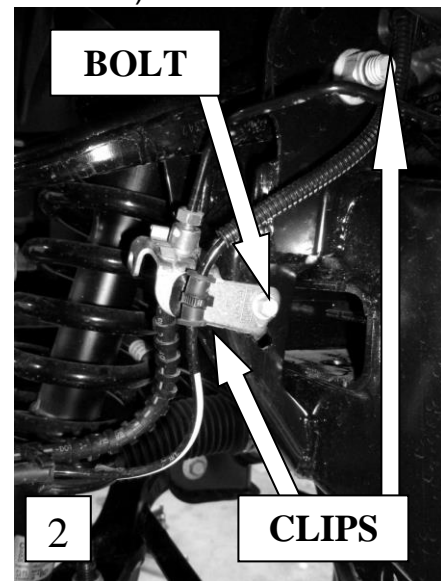
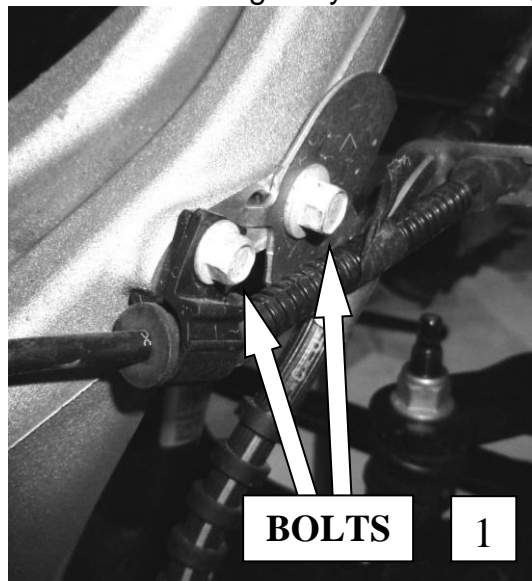

- 1b) Loosen and remove the upper nuts from the sway bar end links. **(photo 3)**

- 1c) Loosen and remove the nuts securing the lower strut mount to the control-arm. **(4)**

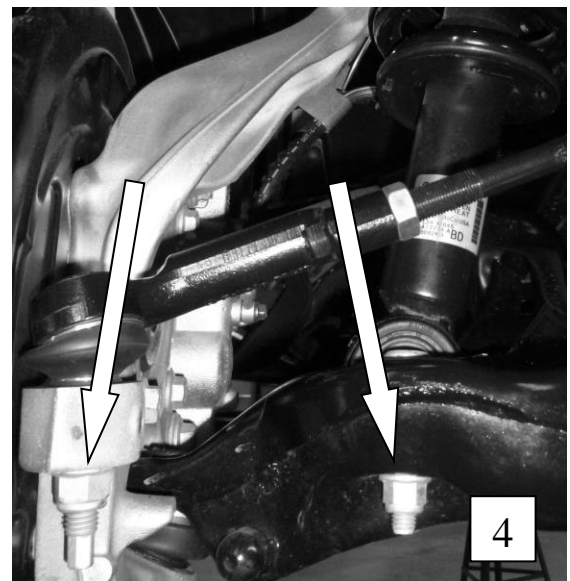
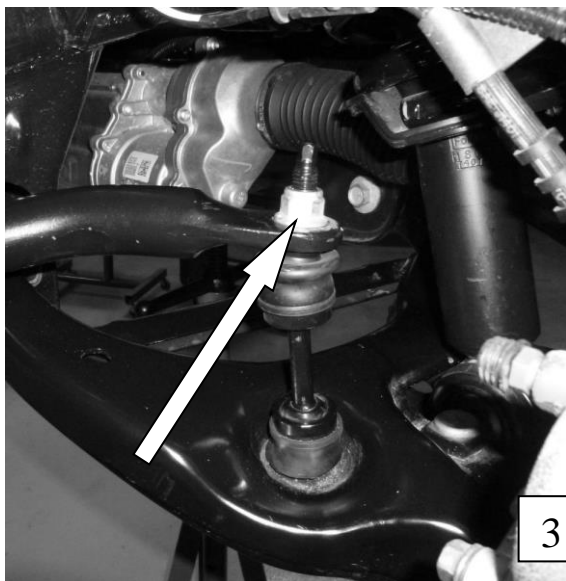

- 1d) Remove the nut securing the tie rod end to the steering knuckle and remove the tie rod end from the steering knuckle. This may require tapping the side of the tie rod end boss with a hammer to unseat the taper. **(photo 4)**
- 1e) Loosen and remove the nut securing the upper ball joint to the steering knuckle. **Please note that the upper control arm may be under tension and, after removing the ball joint, the lower control arm will no longer be supported and may drop downward. Be careful to not allow the brake or ABS lines to become stretched or damaged during this process.** Break the ball joint free from the steering knuckle using the proper ball joint puller. **(photo 5)**
- 1f) Push the steering knuckle and lower control arm down until the lower shock studs are clear from the control arm. Again, do not allow the brake or ABS lines to become stretched or damaged during this process. **(photo 6)**
- 1g) Remove the 3 nuts securing the upper strut mount to the chassis.
- 1h) **Mark the outboard side of the spring and top mount to assist with proper re-assembly and installation. Remove the strut from the chassis.**

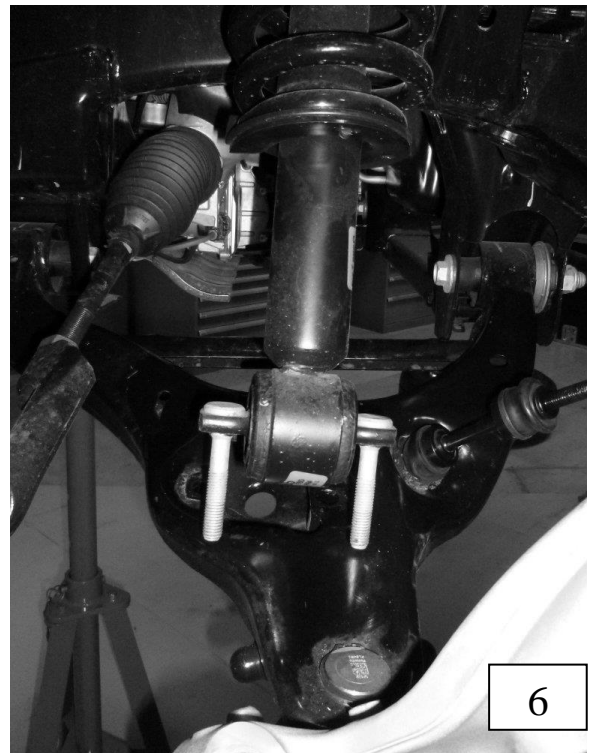
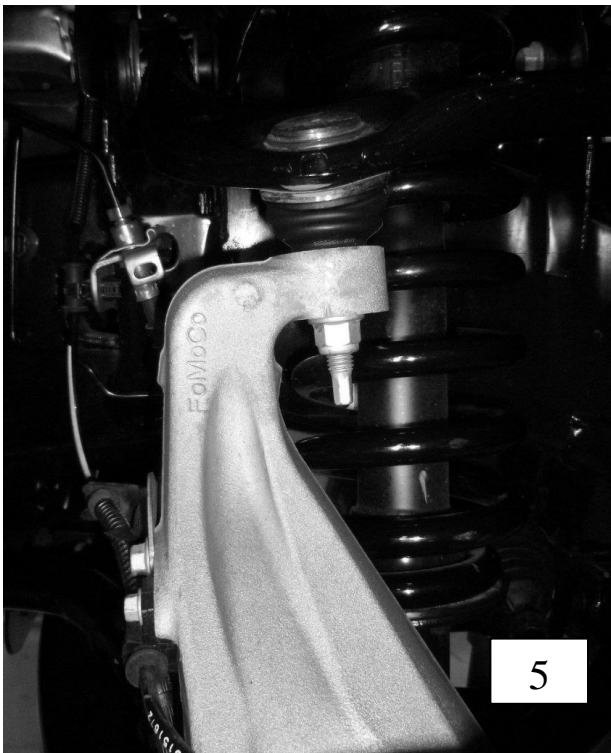

2. COILOVER HEIGHT SETUP

- 2a) Refer to the chart below to determine the “A” measurement to set the drop desired from OEM (Factory height)

Caution: The chart below is designed to use the Belltech 15001 pre-assembled coilover out of the box. This is, an out of the box, lowering solution. Belltech does not recommend lowering beyond what is advertised in the chart below as the performance of the shock may be greatly decreased.

2b) Loosen the set screw on the spring perch.

2c) Using the spanner wrench provided in the kit, turn the bottom spring perch (685-10-039) clock-wise to obtain the "A" measurement that is desired.

2d) Tighten the set screw.

NOTE: IT IS RECOMMENDED TO PRESET A HIGHER "A" MEASUREMENT AND ADJUST DOWN, CLOCKWISE, TO DESIRED VEHICLE HEIGHT ONCE THE COILOVER IS INSTALLED.

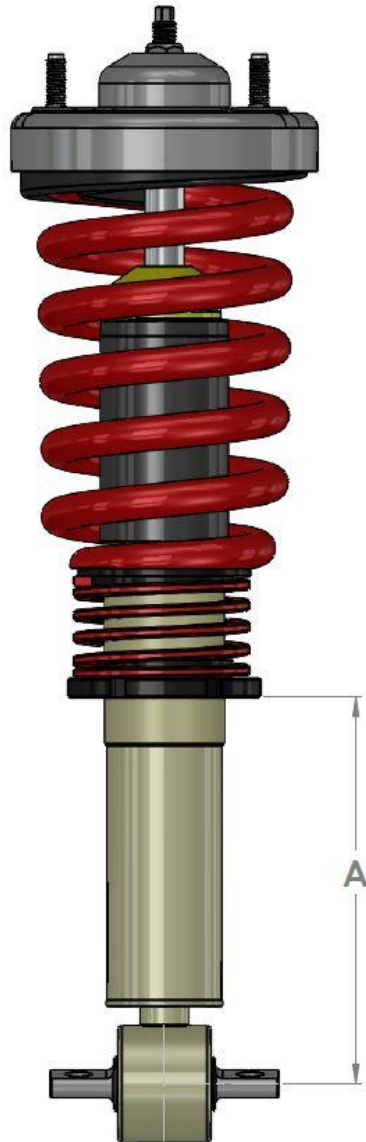

"A" MEASUREMENT	HUB TO FENDER (Drop from OEM)
250 mm	25.4mm (1.0 inch)
240 mm	38.1 mm (1.5 inch)
225 mm	63.5 mm (2.5 inch)
210 mm	88.9mm (3.5 inch)

!! FOR BELLTECH KIT (16001) ONLY, PLEASE READ BELOW!!

THE FRONT COILOVER IS PRE-SET (REBOUND AND COMPRESSION). PLEASE USE THE SUPPLIED ADJUSTMENT KNOB (PART #: 685-25-101) TO ADJUST THE REBOUND VALVE, SEE (FIGURE 1A). ADJUST COMPRESSION BY TURNING, THE BOTTOM, BUILT-IN KNOB CLOCKWISE OR COUNTER-CLOCKWISE. (FIGURE 2A)

CAUTION: MAKING CHANGES TO THE REBOUND AND COMPRESSION VALVES WILL CREATE CHANGES IN THE VEHICLES DRIVING CHARACTERISTICS. PLEASE ADJUST ALL SETTINGS SAFELY AND IN SMALL INCREMENTS AND GET FAMILIAR WITH THE NEW DRIVING CHARACTERISTICS OF THE VEHICLE.

REBOUND	<i>6 CLICKS</i>	<i>OPEN</i>	COMPRESSION	<i>7 CLICKS</i>	<i>OPEN</i>
----------------	-----------------	-------------	--------------------	-----------------	-------------

All adjustments will be done based on a closed valve (max. hard). The closed valve can be reached by turning the adjustment wheel completely to hard (+).

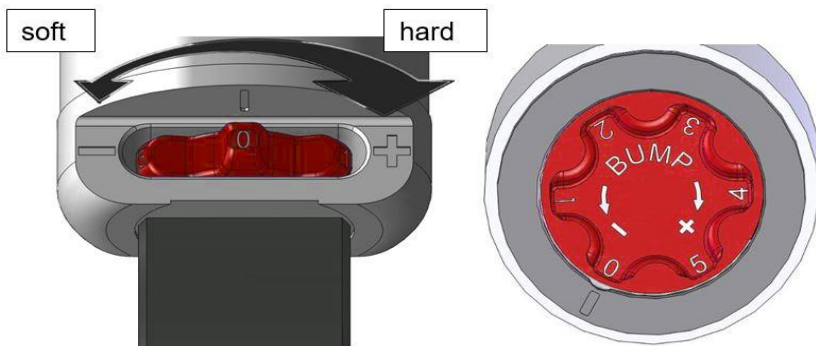
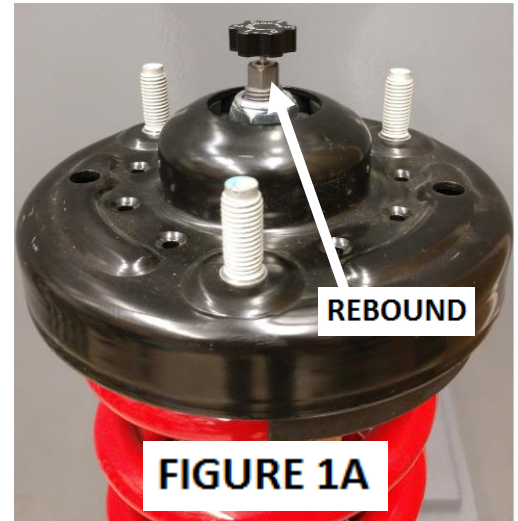

COMPRESSION

3. INSTALLING THE STRUT

3a) Install the top mount into the chassis and secure with the original nuts. Torque nuts to factory specifications. **(Picture 7 & 8)**

3b) Attach the lower strut mount to the lower control arm using the supplied Bolts washers and nylon lock nuts. Torque the supplied nuts to 60 ft/lbs. **(Picture 9)**

3c) Attach the upper ball joint and tie rod ends to the steering knuckle. Torque nuts to factory specifications. Do not over tighten. **(Picture 10)**

3d) Re-attach the upper end link to the sway bar and tighten to factory specification.

3e) Re-attach all brake and ABS lines using OEM bolts and re-attach plastic clips to their original location

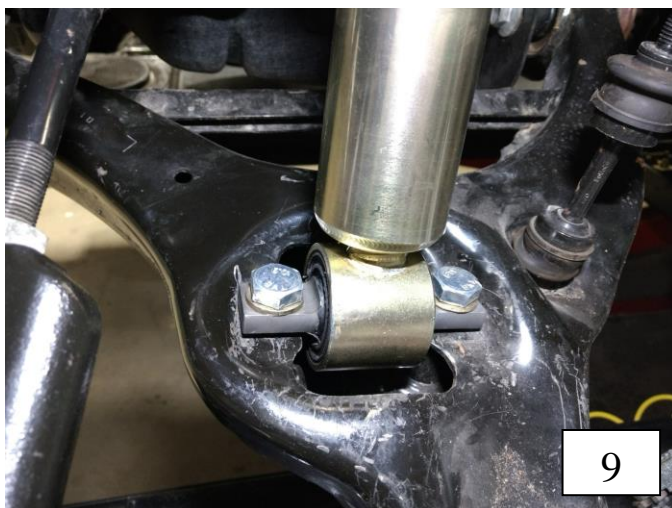
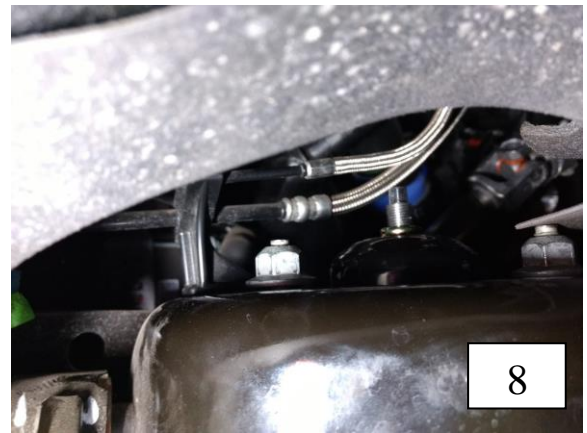
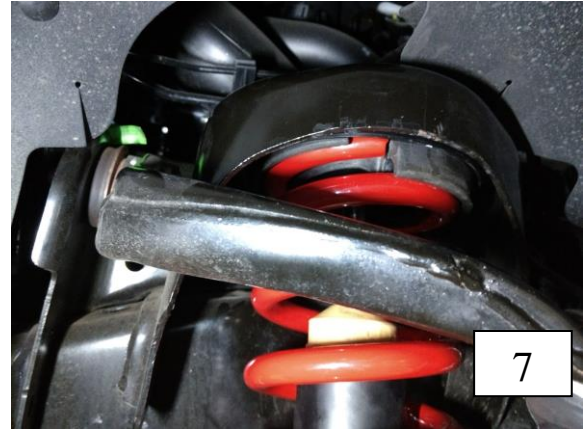

4. ALIGNMENT MODIFICATION

This process is not normally needed for the Belltech 1" to 1.5" drop but is recommended when lowering more than 1.5". This process will allow for additional adjustment to obtain factory spec alignment. If lowering vehicle less than 2", please skip to step 5

- 4a) Remove both bolts securing the lower control arm to the chassis. (photo 11)
- 4b) Pull the lower control arm down below the chassis.
- 4c) Scribe a line 1/2" inward from the edge of the factory alignment slot in the chassis. This will need to be done to all 4 slots on each side of the vehicle. (photo 12)
- 4d) Use a die grinder with a carbide cutting tip to carefully elongate the slot towards the center of the vehicle. Do not elongate beyond the 1/2" outlined as this will allow the control arm to contact the frame.
- 4e) Remove any burrs after grinding and paint the exposed surfaces to prevent corrosion.
- 4f) Reinstall the lower control arms with OEM bolts and torque to factory specifications.

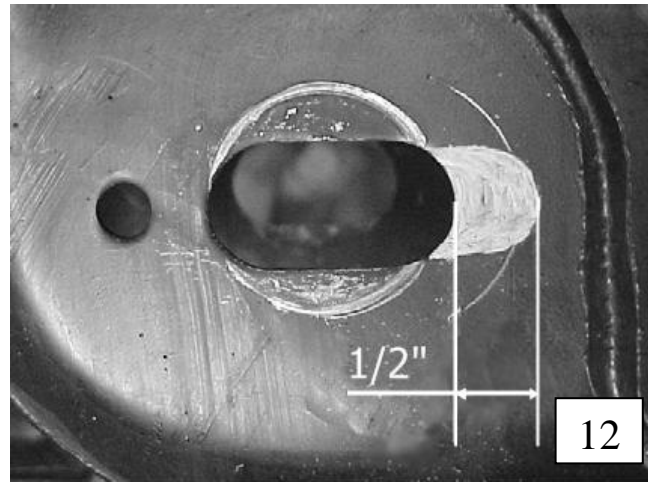
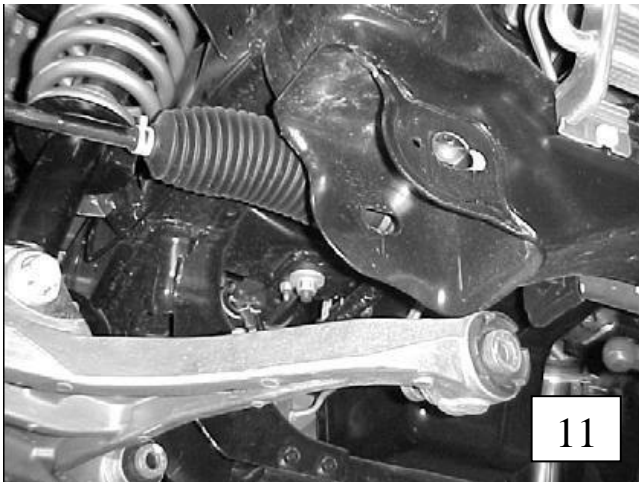

5. FINALIZING THE INSTALLATION

- 5a) All hardware being fastened to the vehicle's original fastening points should be torqued to the proper specifications. To prevent chassis damage, never over-torque the hardware.
- 5b) Check brake hoses and other components for any possible interference.
- 5c) Lift the vehicle and remove the support stands. Carefully lower the vehicle to the ground.
- 5d) **Front end alignment is required immediately following this installation.**
- 5e) Test-drive the vehicle in a remote location so that you can become accustomed to the revised driving characteristics and handling. Be aware that the vehicle will handle substantially different now that it has been modified.
- 5f) Installation is complete. Check all hardware and re-torque at intervals for the first 10, 100, 1000 miles.

Parts List: 15001/16001

Part #	Description	Quantity
15001-100 / 16001-100	COILOVER DAMPER	1
112058	HHCS M14-1.5 X 70MM (LOWER STRUT MOUNT)	2
112298	NYLON LOCK NUT M14-1.5	2
110660	WASHER	2
650-00-018	SPRING PERCH	1
601-10-122	HELPER SPRING	1
650-50-585	INTERMEDIATE RING	1
150-02-105	VENT DISK	1
652-10-799	BUMP STOP	1
652-10-800	DUST COVER	1
5402-001	COILSPRING	1
150-01-265	RUBBER SPRING SEAT	1
150-01-275	TOP MOUNT	1
685-25-101 (16002 ONLY)	ADJUSTMENT KNOB (REBOUND)	1

