

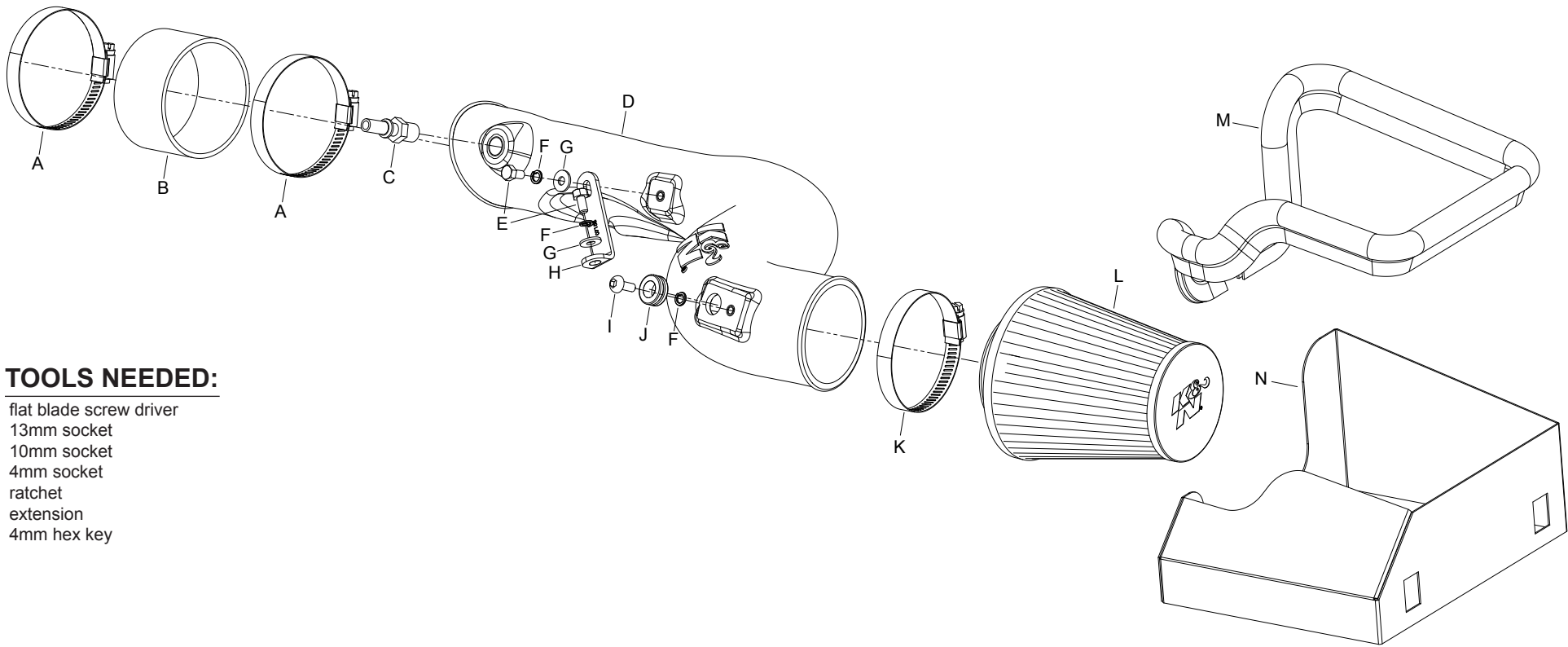

INTAKE SYSTEMS FOR VEHICLES LISTED ARE 50 STATE LEGAL. SEE KNFILTERS.COM FOR CARB STATUS ON EACH PART FOR A SPECIFIC VEHICLE.

# INSTALLATION INSTRUCTIONS

**57-2585**  
**FORD**  
**2013-14 Fusion**  
**L4-2.0L Turbo**



**TOOLS NEEDED:**

- flat blade screw driver
- 13mm socket
- 10mm socket
- 4mm socket
- ratchet
- extension
- 4mm hex key

**PARTS LIST:**

Description	Qty.	Part #	Description	Qty.	Part #	Description	Qty.	Part #
A HOSE CLAMP #48	2	08620	F WASHER, M6 SPLIT LOCK ZINC	3	1-3025	K HOSE CLAMP #56	1	08620
B HOSE; 3-1/4" ID X 2" L	1	08690	G WASHER; 6MM FLAT, SS	2	08269	L AIR FILTER	1	RC-1637
C VENT; STRT, 1/4" NPT	1	08938	H BRACKET; 57-1532, SM."L"	1	07158	M EDGE TRIM (35")	1	102471
D INTAKE TUBE	1	087266	I BOLT; M6 X 1.00 X 12MM, SS	1	07730	N HEAT SHIELD	1	073140
E BOLT; M6 X 1.00 X 12MM	2	07703	J GROMMET; .875ODX.50ID	1	08063			

**NOTE: FAILURE TO FOLLOW INSTALLATION INSTRUCTIONS AND NOT USING THE PROVIDED HARDWARE MAY DAMAGE THE INTAKE TUBE, THROTTLE BODY AND ENGINE.**

**TO START:**

1. Turn off the ignition and disconnect the negative battery cable.

**NOTE: Disconnecting the negative battery cable erases pre-programmed electronic memories. Write down all memory settings before disconnecting the negative battery cable. Some radios will require an anti-theft code to be entered after the battery is reconnected. The anti-theft code is typically supplied with your owner's manual. In the event your vehicles anti-theft code cannot be recovered, contact an authorized dealership to obtain your vehicles anti-theft code.**



2. Lift up and remove the engine cover from the engine.

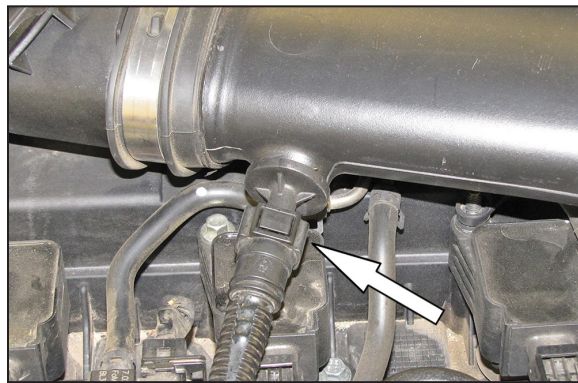

3. Disconnect the crank case vent hose from the factory intake tube by depressing the square locking tab.

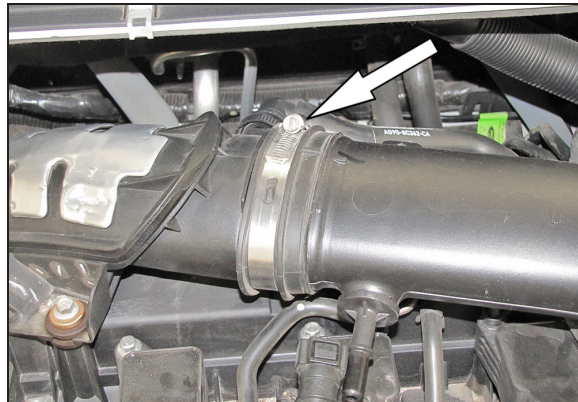

4. Loosen the hose clamp that secures the intake tube to the turbo inlet.

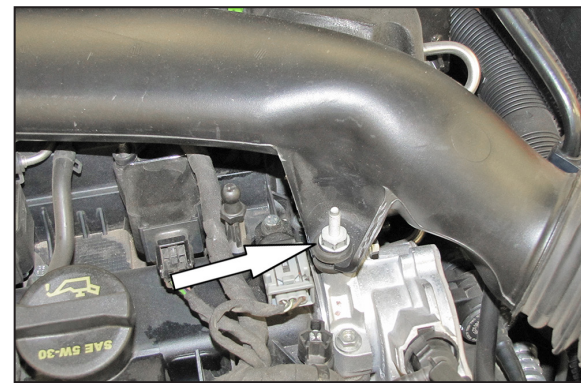

5. Loosen and remove the bolt that secures the intake tube to the engine.

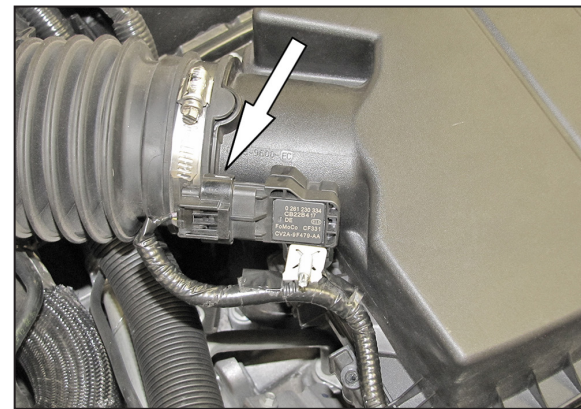

6. Disconnect the temperature sensor electrical connect.  
**NOTE: Two different types of temperature sensors are used. See step 6a.**

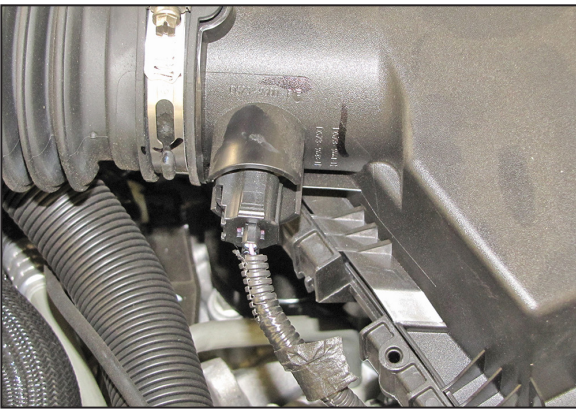

6a. Some vehicles may be equipped with a twist lock style temperature sensor.

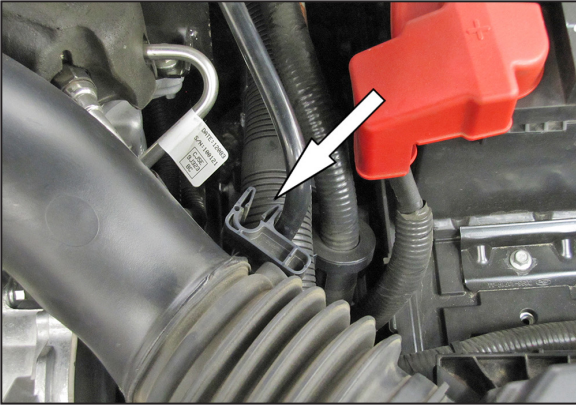

7. Unhook the EVAP tube from the clip on the factory intake tube.



8. Release the two upper air box retaining clips and then remove the complete intake assembly.  
**NOTE: K&N Engineering, Inc., recommends that customers do not discard factory air intake.**



9. Install the coupling hose (08690) onto factory turbo intake tube and secure with provided hose clamp.

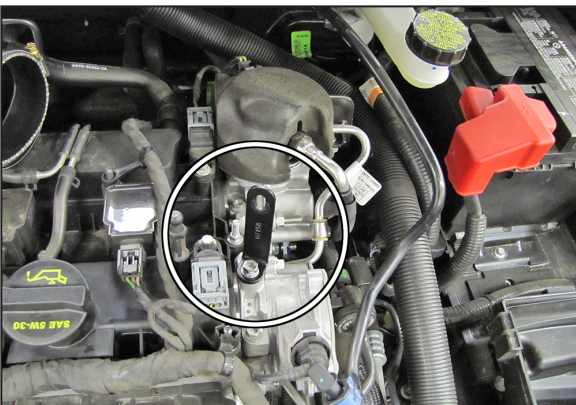

10. Attach tube bracket 07158 onto engine with provided hardware. Do not completely tighten at this time.

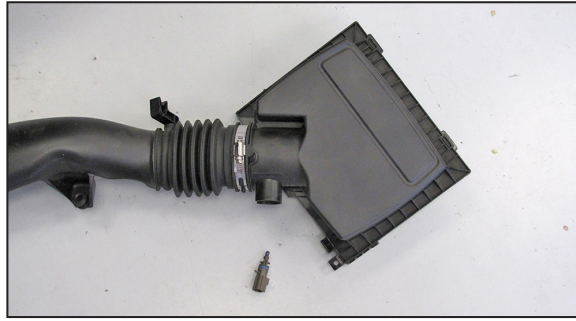

11. Remove the temperature sensor from the factory air box and then remove the "O" ring from the sensor.  
**NOTE: The style sensors WITHOUT the bolt will need to be rotated counter clockwise a ¼ turn and then pulled out of the air box.**

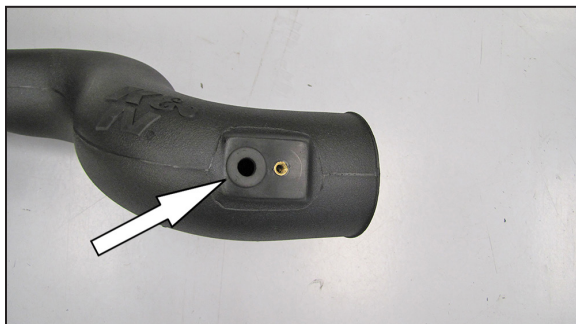

12. Install provided grommet into K&N intake tube.  
**NOTE: On vehicles equipped with the sensor without the bolt to secure it will need the hole in the intake tube drilled out to 3/4" id.**

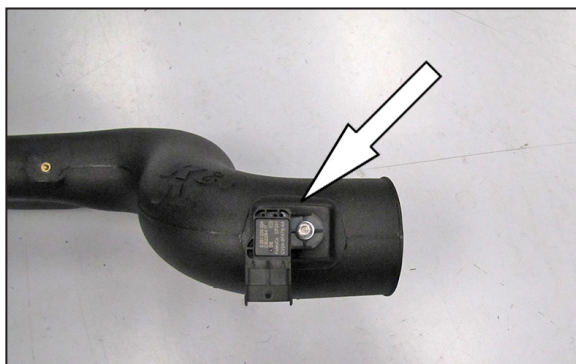

13. Install the temperature sensor into the K&N intake tube and secure with the provided hardware.  
**NOTE: The quarter turn style sensor does not use hardware to hold it in.**

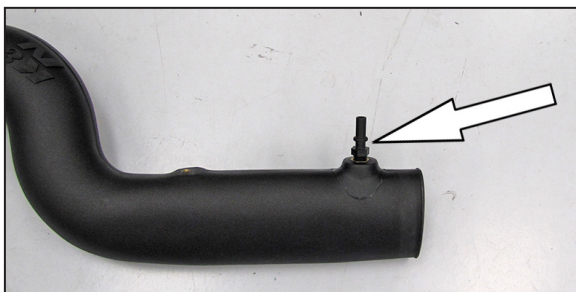

14. Install provided ¼ NPT quick connect fitting onto the K&N intake tube.  
**NOTE: Plastic NPT fittings are easy to cross thread. Install the vent fitting "hand" tight, then turn it two complete turns with a wrench.**

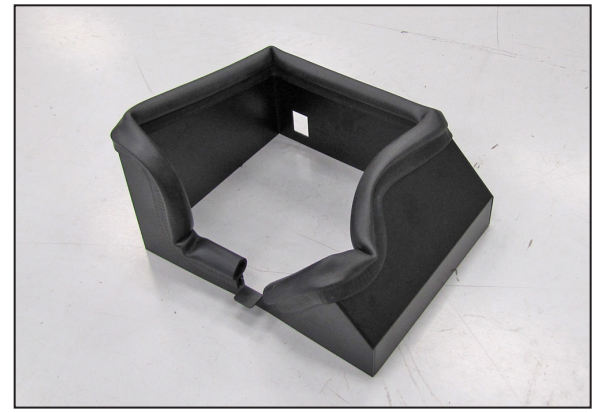

15. Install edge trim onto heat shield as shown.  
**NOTE: Some trimming of the edge trim will be necessary.**

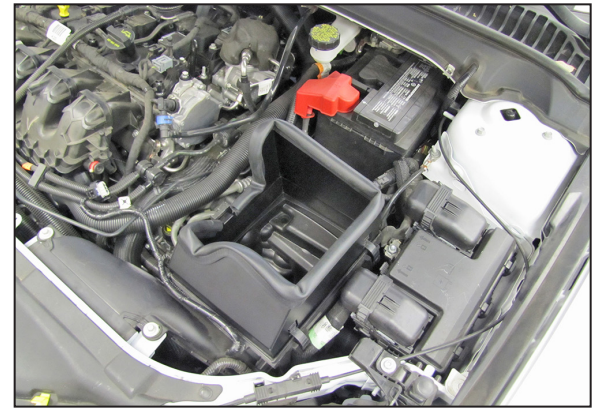

16. Install heat shield onto factory lower air box. Snap in place using factory retaining clips.



17. Install K&N intake tube into the hose and onto the tube mounting bracket. Align with heat shield and secure with provided hardware.



18. Install K&N filter onto K&N intake tube. Secure with provided hose clamp.

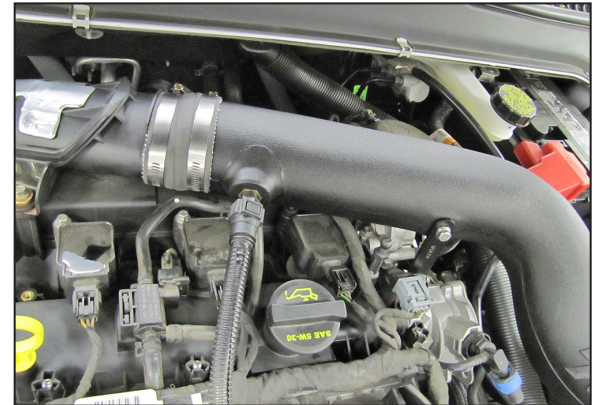

19. Connect crankcase vent line onto quick connect fitting on K&N intake tube.

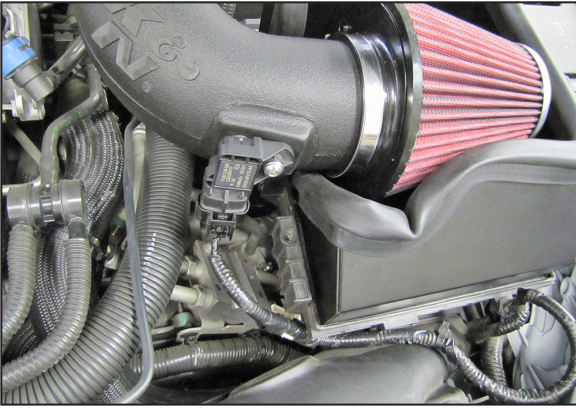

20. Reconnect pressure sensor electrical connector onto sensor.

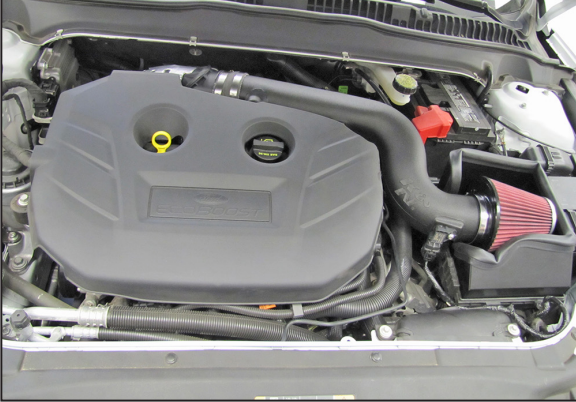

21. Reinstall engine cover.



22. Reconnect the vehicle's negative battery cable. Double check to make sure everything is tight and properly positioned before starting the vehicle.

23. The C.A.R.B. exemption sticker, (attached), must be visible under the hood so that an emissions inspector can see it when the vehicle is required to be tested for emissions. California requires testing every two years, other states may vary.

24. It will be necessary for all K&N® high flow intake systems to be checked periodically for realignment, clearance and tightening of all connections. Failure to follow the above instructions or proper maintenance may void warranty.

#### ROAD TESTING:

1. Start the engine with the transmission in neutral or park, and the parking brake engaged. Listen for air leaks or odd noises. For air leaks secure hoses and connections. For odd noises, find cause and repair before proceeding. This kit will function identically to the factory system except for being louder and much more responsive.

2. Test drive the vehicle. Listen for odd noises or rattles and fix as necessary.

3. If road test is fine, you can now enjoy the added power and performance from your kit.

4. K&N Engineering, Inc., requires cleaning the intake system's air filter element every 100,000 miles. When used in dusty or off-road environments, our filters will require cleaning more often. We recommend that you visually inspect your filter once every 25,000 miles to determine if the screen is still visible. When the screen is no longer visible some place on the filter element, it is time to clean it. To clean and re-oil, purchase our filter Recharger® service kit, part number 99-5050 or 99-5000 and follow the easy instructions.

**INTAKE SYSTEMS FOR VEHICLES LISTED ARE 50 STATE LEGAL. SEE KNFILTERS.COM FOR CARB STATUS ON EACH PART FOR A SPECIFIC VEHICLE.**