



INTAKE SYSTEMS FOR VEHICLES LISTED ARE 50 STATE LEGAL. SEE KNFILTERS.COM FOR CARB STATUS ON EACH PART FOR A SPECIFIC VEHICLE.

INSTALLATION INSTRUCTIONS

57-3514
HONDA
2004-08 S2000
L4-2.2L
2000-03 S2000
L4-2.0L

TOOLS NEEDED:

- 13mm Socket
- 10mm Wrench
- 7/16" Socket
- 5/8"OD Drill Bit
- Drill
- Flat Blade Screwdriver
- Pliers
- Phillips Head Screwdriver
- Ratchet w/Long Extension
- Socket
- Wire Cutters

PARTS LIST:

Description	Qty.	Part #	Description	Qty.	Part #	Description	Qty.	Part #
A Hose Clamp #44	2	08577	K Bolt 6mm-1.00x20mm F/H/A SS	1	08376	U Bracket Large "L"	1	08015
B Hose; 2.75"ID to 3"ID Hump	1	08421	L Washer, Conical, Nylon, Black	1	08180	V Filter Adapter	1	21561
C Intake Tube	1	087042	M Bracket	1	08025	W Bracket, Small "L"	1	08023
D Hose, 4mm x 12"L	1	08147	N Washer, 1/4"ID x 5/8"OD, SAE	13	08275	X Hose Clamp, #64	1	08648
E 1/4"ID x 10-1/2" Silicone Hose	1	08400	O Bolt, m6-1.00x16mm HexHd. Tap	7	07703	Y Air Filter	1	RP-4980
F Hose, 1/2"ID x 14"L Blk. Hose	1	08402	P Nut, 6mm Nylock HexHd.	6	07553	Z Caplug; .750"ID	1	08119
G Hose 4mm ID x 18" Blk. Silicone	1	08153	Q Wave Washer	2	08174	AA Hose Clamp #6 Mini	1	08407
H Hose Clamp #004	2	21850	R Cable Ties, 12" Black	1	21590	AB Grommet; 15/16"OD, 3/8"ID, 17/32" Thk.	1	08100
I Hose Clamp #48	1	08601	S Edge Trim, 48"L	1	102485			
J Saddle Bracket	1	078855	T Heat Shield	1	07458			

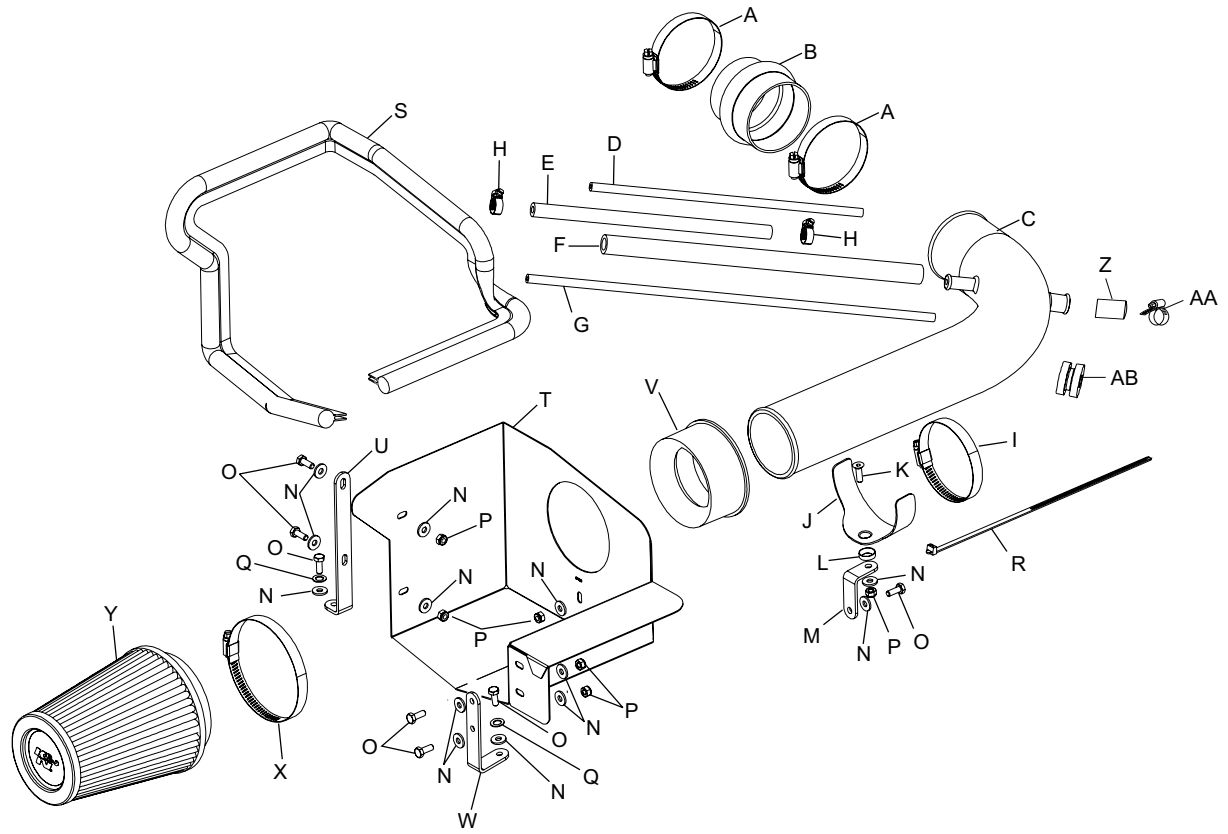

NOTE: FAILURE TO FOLLOW INSTALLATION INSTRUCTIONS AND NOT USING THE PROVIDED HARDWARE MAY DAMAGE THE INTAKE TUBE, THROTTLE BODY AND ENGINE.

TO START:

1. Turn off the ignition and disconnect the negative battery cable.
NOTE: Disconnecting the negative battery cable erases pre-programmed electronic memories. Write down all memory settings before disconnecting the negative battery cable. Some radios will require an anti-theft code to be entered after the battery is reconnected. The anti-theft code is typically supplied with your owner's manual. In the event your vehicles' anti-theft code cannot be recovered, contact an authorized dealership to obtain your vehicles anti-theft code.

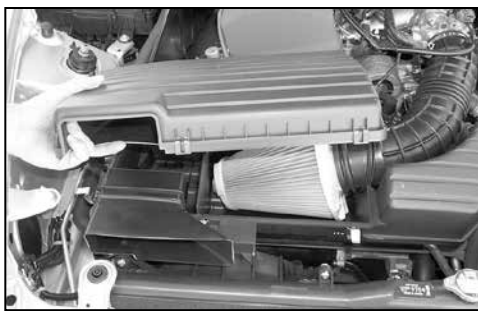

2. Release the 6 clips that retain the air box top, then remove the top.



3. On vehicles equipped with air injection pump, detach the air injection pump hose from the stock intake tube.



4. Remove the crank case vent hardline from the stock intake tube.



4a. On vehicles equipped with an air temperature sensor, disconnect the air temperature sensor electrical connection as shown.



5. Loosen the hose clamp at the throttle body, then, remove the stock intake tube.



6. On vehicles equipped with air control solenoid, loosen and remove the screw and push clip that secures the air control solenoid valve to the air box base.



7. Loosen and remove the 3 bolts that secure the air cleaner base, then remove the air cleaner base.
NOTE: K&N Engineering, Inc., recommends that customers do not discard factory air intake.

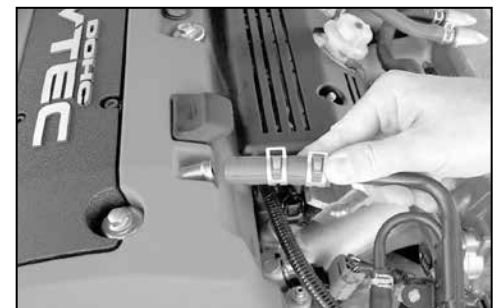

8. Remove the crank case vent hose from the vent on the cam cover.

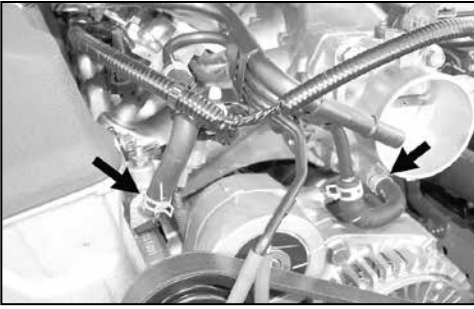

9. Detach the coolant hose from the fitting on the intake manifold, and from the fitting on the underside of the throttle body.



10. Detach the air control valve vacuum hose and the air control solenoid vacuum hose from the hard lines.



11. On vehicles equipped with air injection pump, detach the vacuum hose from the air control solenoid valve vacuum control solenoid valve.



12. On vehicles equipped with air injection pump, detach the vacuum hose from the air control vacuum check valve.



13. Remove the pipe assembly.



14. On vehicles equipped with air injection pump, attach the provided 4mm (long) vacuum hose to the air control solenoid valve.



15. On vehicles equipped with air injection pump, attach the provided 4mm (short) vacuum hose to the check valve.

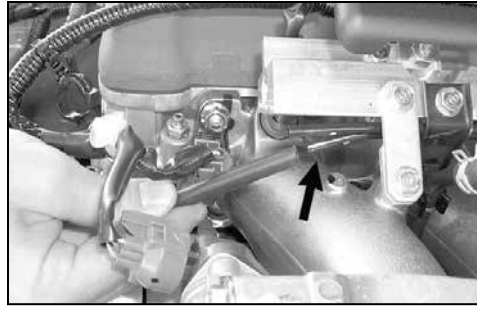

16. On vehicles equipped with air injection pump, attach the air control solenoid valve vacuum hose to the air control valve hard line. (lower hard line).

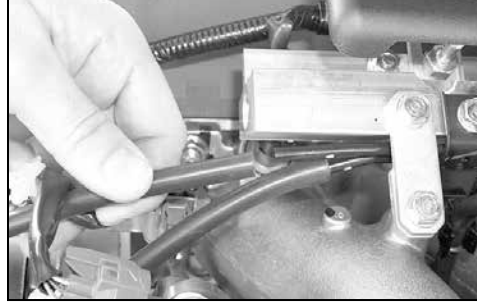

17. On vehicles equipped with air injection pump, attach the check valve vacuum line to the check valve hard line (upper hard line).



18. Attach the provided 1/4" reinforced hose to the fitting on the intake manifold and the fitting on the underside of the throttle body.



19. Using the provided hardware assemble the saddle bracket and the "L" bracket assembly.

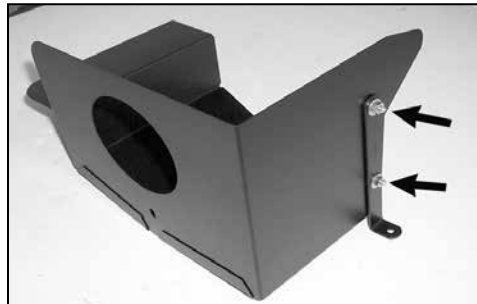

20. Using the provided hardware attach the long "L" bracket to the heat shield.

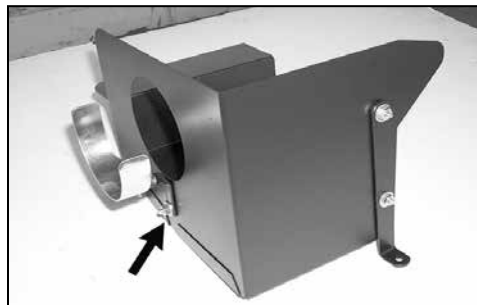

21. Using the provided hardware attach the saddle bracket assembly to the heat shield.



22. Install the edge trim to the heat shield assembly.

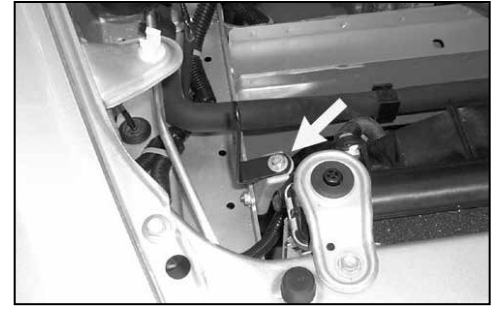

23. Using the provided hardware, install the small "L" bracket onto the vehicle as shown.

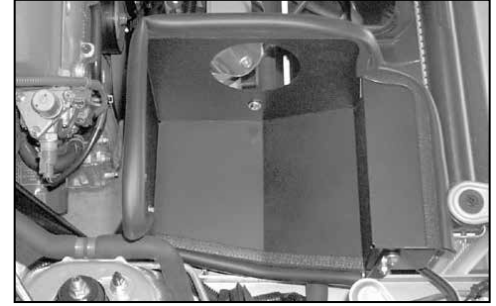

24. Using the provided hardware, install the heat shield assembly and secure the brackets to the original air box mounting locations.



25. Install the silicone hump hose with provided hose clamps, onto the K&N® intake tube as shown.



26. Install the intake K&N® tube and secure the hump hose to the throttle body as shown.

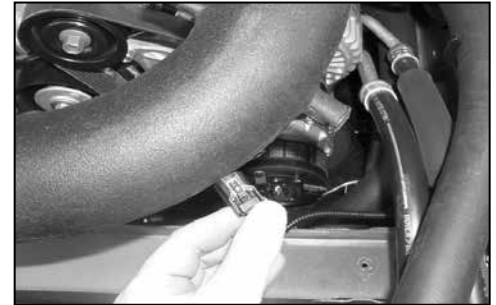

26a. On vehicles equipped with an air temperature sensor, position the air temperature sensor wiring harness on the intake tube for best fit and mark the position on the intake tube with a marker for drilling.



26b. Remove the intake tube from the vehicle and drill a 5/8" id hole in the tube at the position indicated in the previous step.



26c. Install the provided grommet into the hole drilled in the K&N® intake tube as shown.

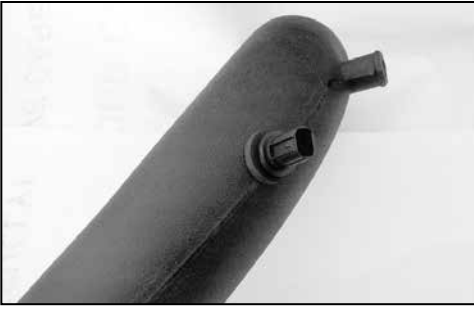

26d. Remove the air temperature sensor from the stock intake tube and install it into the grommet installed in the K&N® intake tube in the previous step as shown.



27. Install the K&N® intake tube onto the throttle body and align it with the saddle clamp on the heat shield and secure with the provided hose clamps.

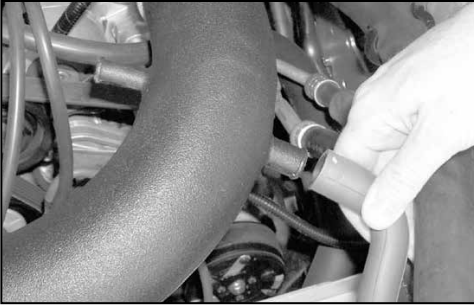

28. On vehicles equipped with air injection pump, attach the air injection hose to the fitting on the K&N® intake tube.

NOTE: Remove the stock pipe assembly from the injection hose.



28a. On vehicles not equipped with an air injection pump, install the provided "Caplug" onto the vent port on the K&N® intake tube and secure with the provided hose clamp as shown.



28b. On vehicles equipped with an air temperature sensor, reconnect the air temperature sensor electrical connection as shown.

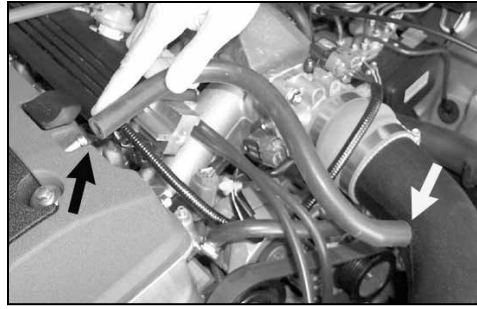

29. Attach the provided 1/2" hose to the crank case vent on the cam cover, then attach the other end to the vent on the K&N® intake tube.



30. On vehicles equipped with an air control solenoid valve, attach the air control solenoid valve to the K&N® intake tube using the original screw removed in step 6.

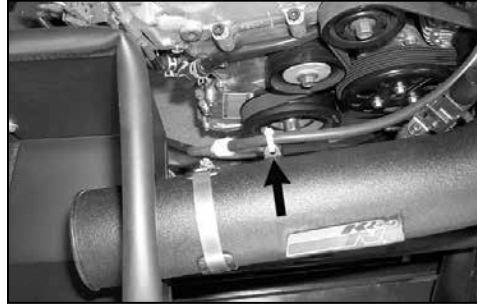

31. Secure the vacuum hose to the K&N® intake tube using the provided cable tie.

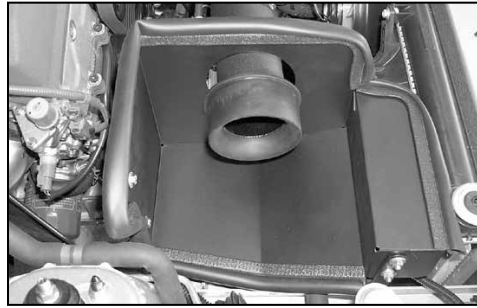

32. Install the radiused adapter onto the K&N® intake tube.



33. Install the K&N® air filter onto the K&N® intake tube and secure with the provided hose clamp.
NOTE: Drycharger® air filter wrap; part number RC-5149DK is available to purchase separately. To learn more about Drycharger® filter wraps or look up color availability please visit <http://www.knfilters.com>®.



34. Reconnect the vehicle's negative battery cable. Double check to make sure everything is tight and properly positioned before starting the vehicle.

35. The C.A.R.B. exemption sticker, (attached), must be visible under the hood so that an emissions inspector can see it when the vehicle is required to be tested for emissions. California requires testing every two years, other states may vary.

36. It will be necessary for all K&N® high flow intake systems to be checked periodically for realignment, clearance and tightening of all connections. Failure to follow the above instructions or proper maintenance may void warranty.

ROAD TESTING:

1. Start the engine with the transmission in neutral or park, and the parking brake engaged. Listen for air leaks or odd noises. For air leaks secure hoses and connections. For odd noises, find cause and repair before proceeding. This kit will function identically to the factory system except for being louder and much more responsive.

2. Test drive the vehicle. Listen for odd noises or rattles and fix as necessary.

3. If road test is fine, you can now enjoy the added power and performance from your kit.

4. K&N Engineering, Inc., requires cleaning the intake system's air filter element every 100,000 miles. When used in dusty or off-road environments, our filters will require cleaning more often. We recommend that you visually inspect your filter once every 25,000 miles to determine if the screen is still visible. When the screen is no longer visible some place on the filter element, it is time to clean it. To clean and re-oil, purchase our filter Recharger® service kit, part number 99-5050 or 99-5000 and follow the easy instructions.

INTAKE SYSTEMS FOR VEHICLES LISTED ARE 50 STATE LEGAL. SEE KNFILTERS.COM FOR CARB STATUS ON EACH PART FOR A SPECIFIC VEHICLE.