



AIRCHARGER®

HIGH-FLOW INTAKE KITS

NOT LEGAL FOR SALE OR USE ON ANY POLLUTION CONTROLLED MOTOR VEHICLE IN CALIFORNIA OR STATES ADOPTING CALIFORNIA EMISSION PROCEDURES.
See knfilters.com for CARB status on each part for a specific vehicle

INSTALLATION INSTRUCTIONS

63-5301
HYUNDAI
2013-15 Santa Fe
L4-2.4L

TOOLS NEEDED:

- Ratchet
- Extension
- 10mm socket
- pliers
- 10mm wrench
- flat blade screw driver
- 9/16" wrench
- 5/8" wrench

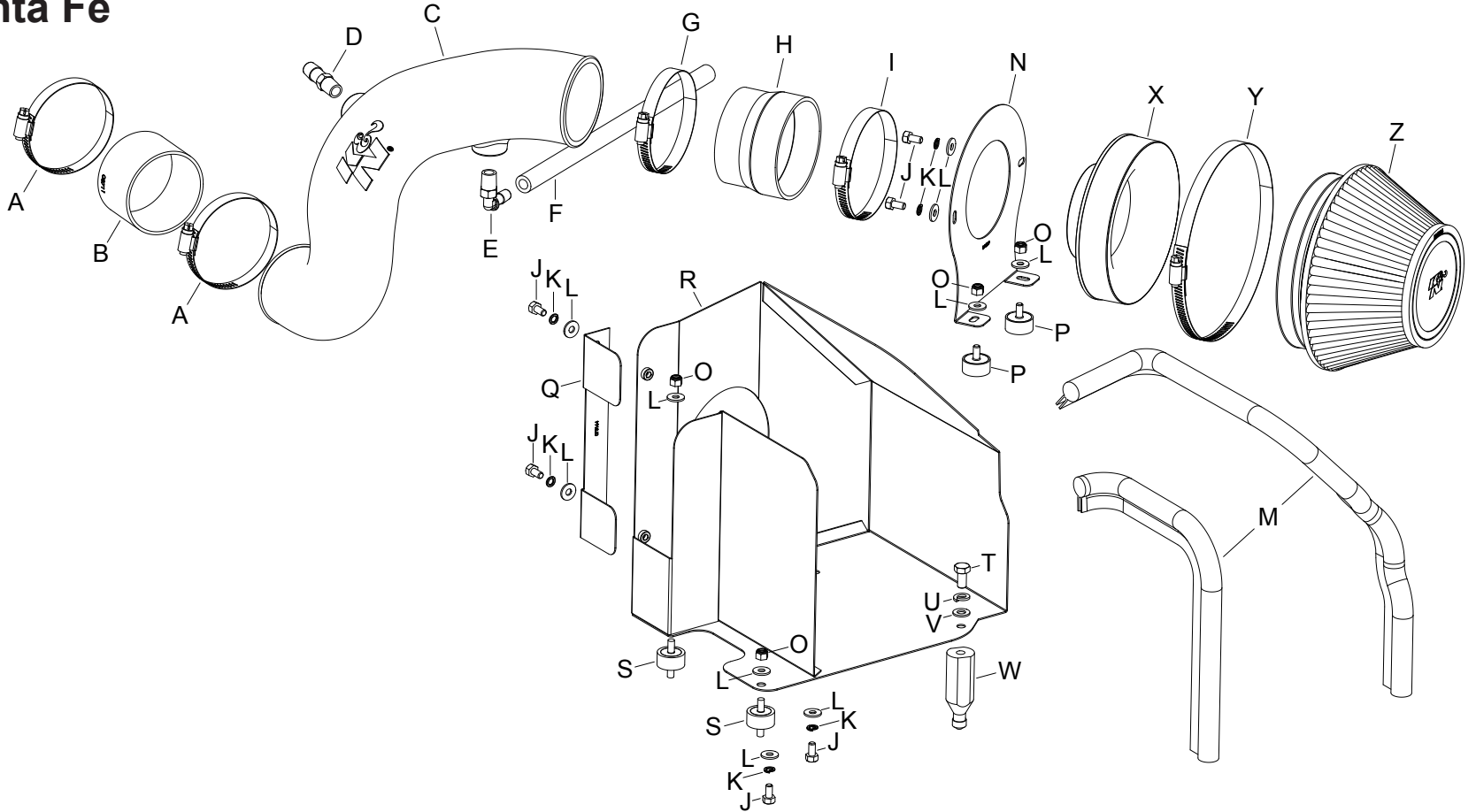

PARTS LIST:

Description	Qty.	Part #	Description	Qty.	Part #	Description	Qty.	Part #
A Hose Clamp #48	2	08601	I Hose Clamp #56	1	08620	R Heat Shield	1	073163
B Hose; 3" ID X 2"L Reinforced	1	08711	J Bolt; M6 X 1.00 X 12MM, SS	6	07727	S Stud; M6-1.00 M/M, Rubber	2	07027
C Intake Tube	1	087277	K Washer; M6 Split Lock Zinc	6	1-3025	T Bolt; 8MM-1.25 X 16MM	1	07844
D Vent; STRT 1/2" Hose , 1/4", Plas	1	080022	L Washer; 6MM Flat, SS	10	08269	U Washer; M8 Split Lock Zinc	1	1-3036
E Vent; 1/4 NPT, 90 deg., 3/8" Hose	1	08523	M Edge Trim (57")	1	102470	V Washer; 8MM, Flat, SS	1	08272
F Hose; 3/8" ID X 12"L	1	08412	N Bracket; Tube, 69-2528, Mild	1	064309	W Standoff; 6.0 Ford Airbox	1	06532
G Hose Clamp #52	1	08610	O Nut; 6MM Nylock, Hexhead, SS	4	07512	X Adapter; Universal, 6" Filter 3.5"	1	21512-1
H Hose; 3.5"ID To 3.25" ID X 2.5"L	1	08496	P Stud; Rubber MNT, M/F, 1/2" L	2	070228	Y Hose Clamp #104	1	08697
			Q Heat Shield	1	073164	Z Air Filter	1	RU-4600

NOTE: FAILURE TO FOLLOW INSTALLATION INSTRUCTIONS AND NOT USING THE PROVIDED HARDWARE MAY DAMAGE THE INTAKE TUBE, THROTTLE BODY AND ENGINE.

TO START:

1. Turn off the ignition and disconnect the negative battery cable.
NOTE: Disconnecting the negative battery cable erases pre-programmed electronic memories. Write down all memory settings before disconnecting the negative battery cable. Some radios will require an anti-theft code to be entered after the battery is reconnected. The anti-theft code is typically supplied with your owner's manual. In the event your vehicles anti-theft code cannot be recovered, contact an authorized dealership to obtain your vehicles anti-theft code.



2. Lift up and remove the decorative engine cover from the engine.

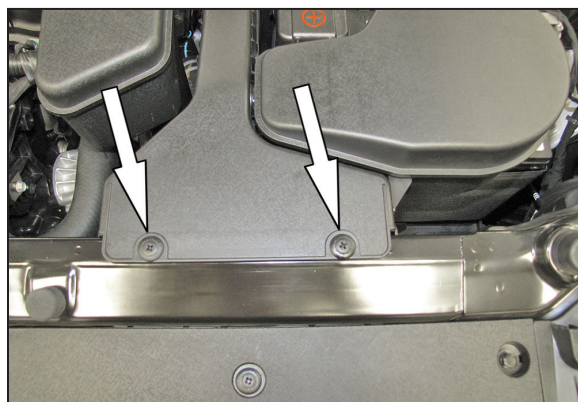

3. Remove the two plastic retaining screws and then remove the fresh air intake duct from the vehicle.

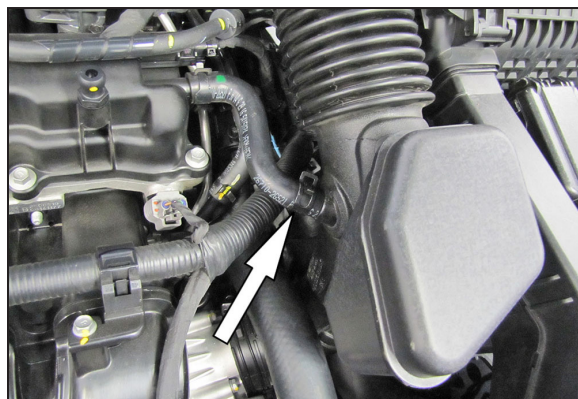

4. Release the spring clamp securing the crank case vent hose to the intake tube and then disconnect the crank case vent hose from the intake tube.



5. Release the spring clamp securing the EVAP vent hose to the valve and then disconnect the hose from the valve.

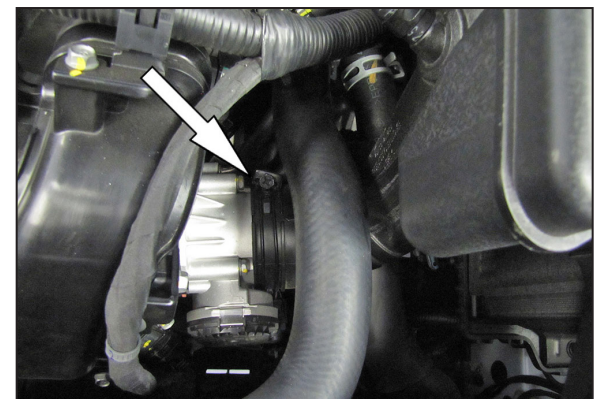

6. Loosen the hose clamp securing the intake tube to the throttle body.

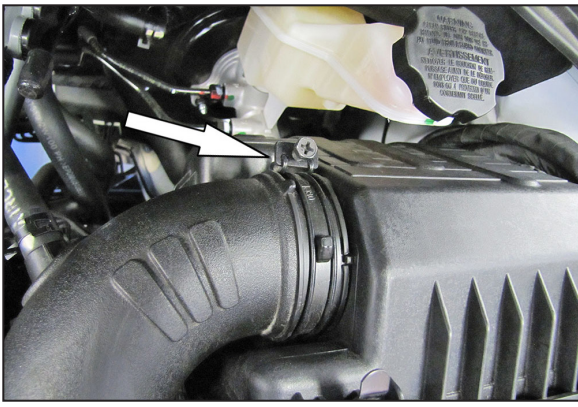

7. Loosen the hose clamp securing the intake tube to the air filter housing and then remove the intake tube from the vehicle.

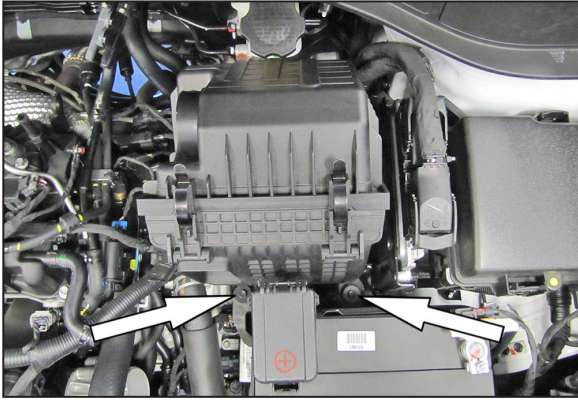

8. Remove the two bolts that secure the air filter housing and then remove the air filter housing from the vehicle.

NOTE: The air box is also held into position with a grommet. Lifting the air box up will dislodge it from the grommet.

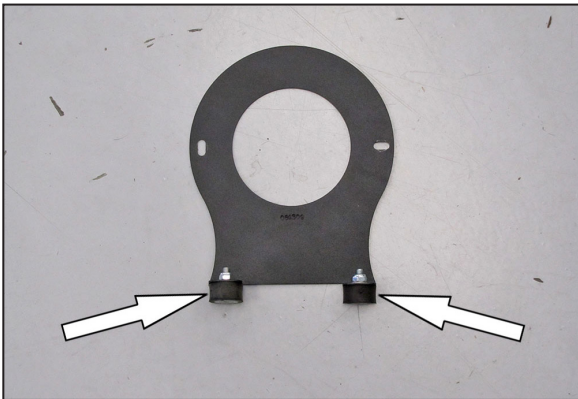

9. Install the two male/female rubber mounted studs onto the filter mounting bracket using the provided hardware.



10. Install the filter adapter onto the mounting bracket and secure using the provided hardware. **NOTE: The bracket part number will be covered over by the filter adapter when it is installed on the correct side of the bracket.**

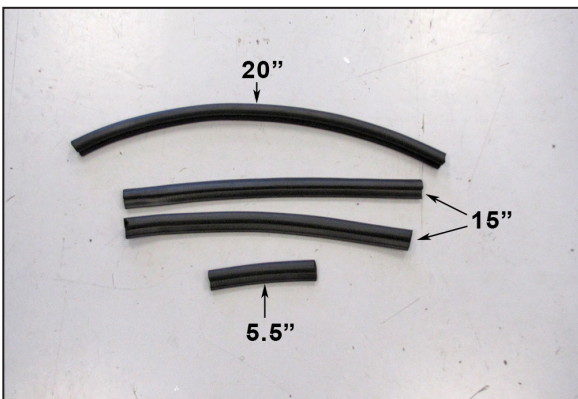

11. Cut the provided edge trim into the following lengths, 5-1/2", 2 x 15" and 20"

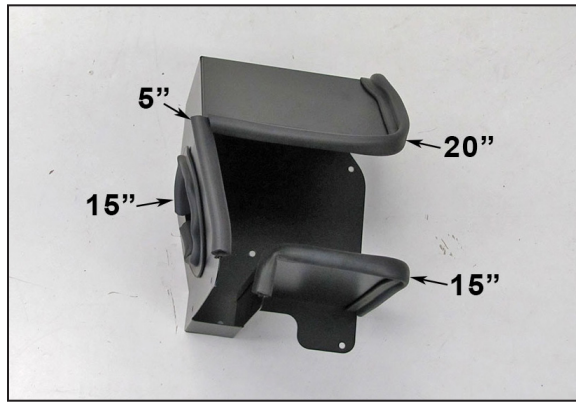

12. Install the edge trim onto the heat shield as shown.



13. Install the filter mounting bracket assembly into the heat shield and secure with the provided hardware.



14. Install the heat shield mounting post onto the heat shield and secure with the provided hardware.



15. Install the K&N® air filter onto the filter adapter and secure with the provided hose clamp.

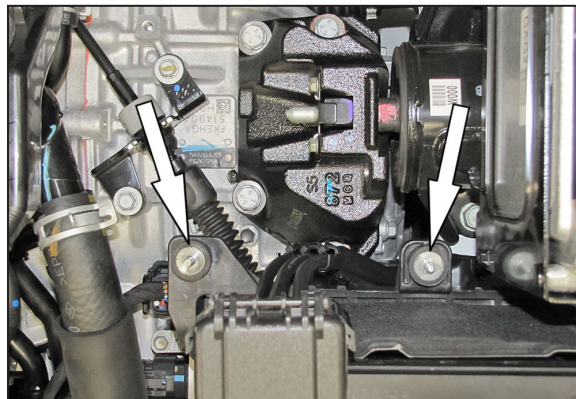

17. Install the heat shield assembly onto the rubber mounted studs and insert the mounting post into the mounting grommet. Secure the heat shield with the hardware provided.

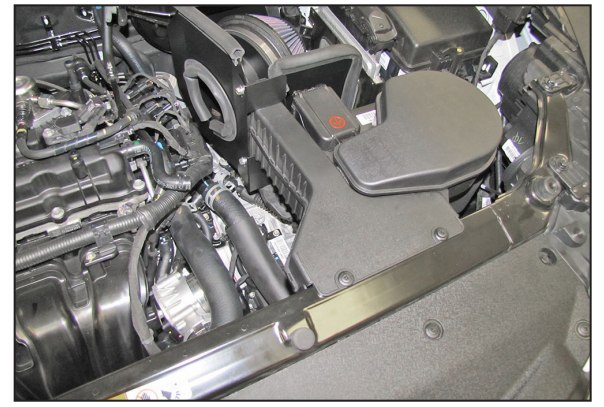

18. Install the fresh air intake scoop into the heat shield and onto the core support. Secure the scoop to the heat shield using the panel and hardware and to the core support using the factory retainers.

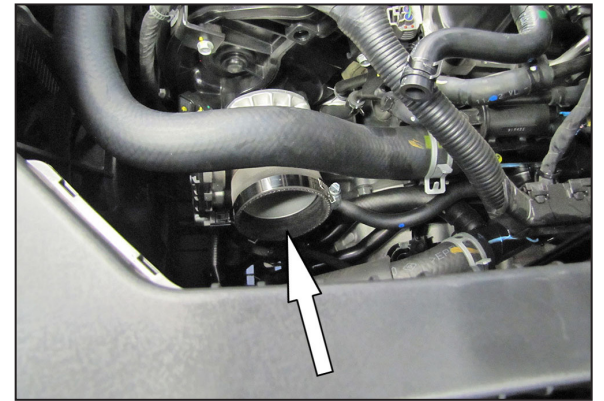

19. Install the provided coupling hose (08711) onto the throttle body and secure with the provided hose clamp.

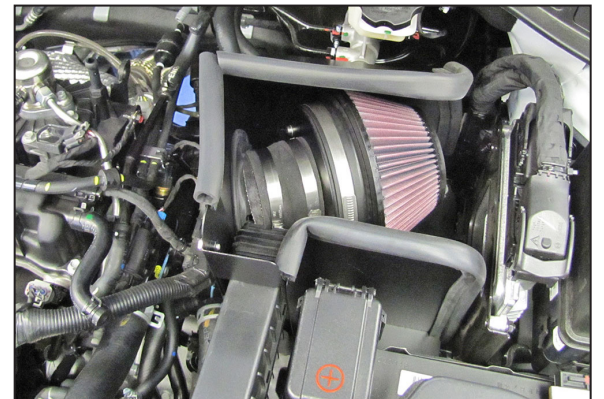

20. Install the provided step coupler (08496) onto the filter adapter and secure with the provided hose clamp.

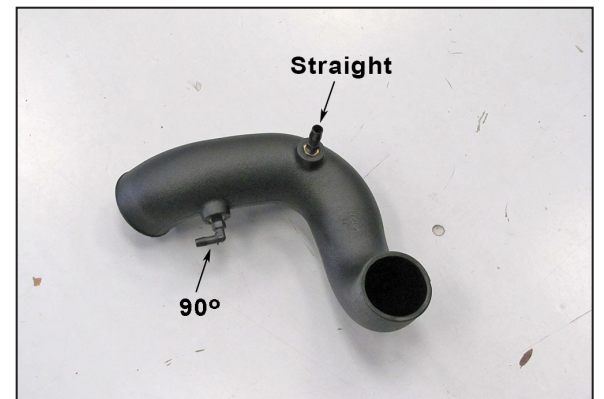

21. Install the 90° and straight vent fitting into the K&N® intake tube as shown.



22. Install the provided vent hose onto the 90° vent fitting as shown.

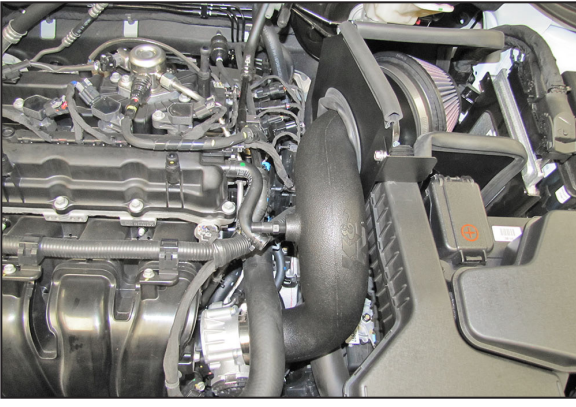

23. Install the K&N® intake tube into the coupling hose at the filter adapter and then into the hose at the throttle body, adjust the tube for best fit and then secure with the provided hose clamps.

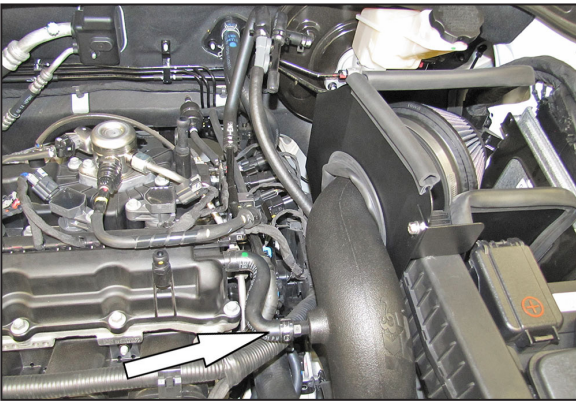

24. Connect the factory crank case vent hose to the fitting installed into the K&N® intake tube and then connect the EVAP hose to the factory valve.



25. Reinstall the decorative engine cover.



26. Reconnect the vehicle's negative battery cable. Double check to make sure everything is tight and properly positioned before starting the vehicle.

27. It will be necessary for all K&N® high flow intake systems to be checked periodically for realignment, clearance and tightening of all connections. Failure to follow the above instructions or proper maintenance may void warranty.

ROAD TESTING:

1. Start the engine with the transmission in neutral or park, and the parking brake engaged. Listen for air leaks or odd noises. For air leaks secure hoses and connections. For odd noises, find cause and repair before proceeding. This kit will function identically to the factory system except for being louder and much more responsive.

2. Test drive the vehicle. Listen for odd noises or rattles and fix as necessary.

3. If road test is fine, you can now enjoy the added power and performance from your kit.

4. K&N Engineering, Inc., requires cleaning the intake system's air filter element every 100,000 miles. When used in dusty or off-road environments, our filters will require cleaning more often. We recommend that you visually inspect your filter once every 25,000 miles to determine if the screen is still visible. When the screen is no longer visible some place on the filter element, it is time to clean it. To clean and re-oil, purchase our filter Recharger® service kit, part number 99-5050 or 99-5000 and follow the easy instructions.

NOT LEGAL FOR SALE OR USE ON ANY POLLUTION CONTROLLED MOTOR VEHICLE IN CALIFORNIA OR STATES ADOPTING CALIFORNIA EMISSION PROCEDURES.

See knfilters.com for CARB status on each part for a specific vehicle