



# TYPHOON INTAKE SYSTEMS

INTAKE SYSTEMS FOR VEHICLES LISTED ARE 50 STATE LEGAL. SEE KNFILTERS.COM FOR CARB STATUS ON EACH PART FOR A SPECIFIC VEHICLE.

## INSTALLATION INSTRUCTIONS

**69-3514TTK**  
**FORD**  
**2006-09 Fusion**  
**L4-2.3L**  
**2010-12 Fusion**  
**L4-2.5L**

NOTE: EXCLUDES LEV2 SULEV 2006-2009  
TEST GROUPS 6FMXV02.31ZA, 7FMXV02.3VZT,  
8FMXV02.3VZT, 9FMXV02.3VZT

### TOOLS:

- 3mm Allen Wrench
- 8mm Socket
- 10mm Socket
- 10mm Wrench
- Extension
- Flat Blade Screwdriver
- Phillips Screwdriver
- Ratchet

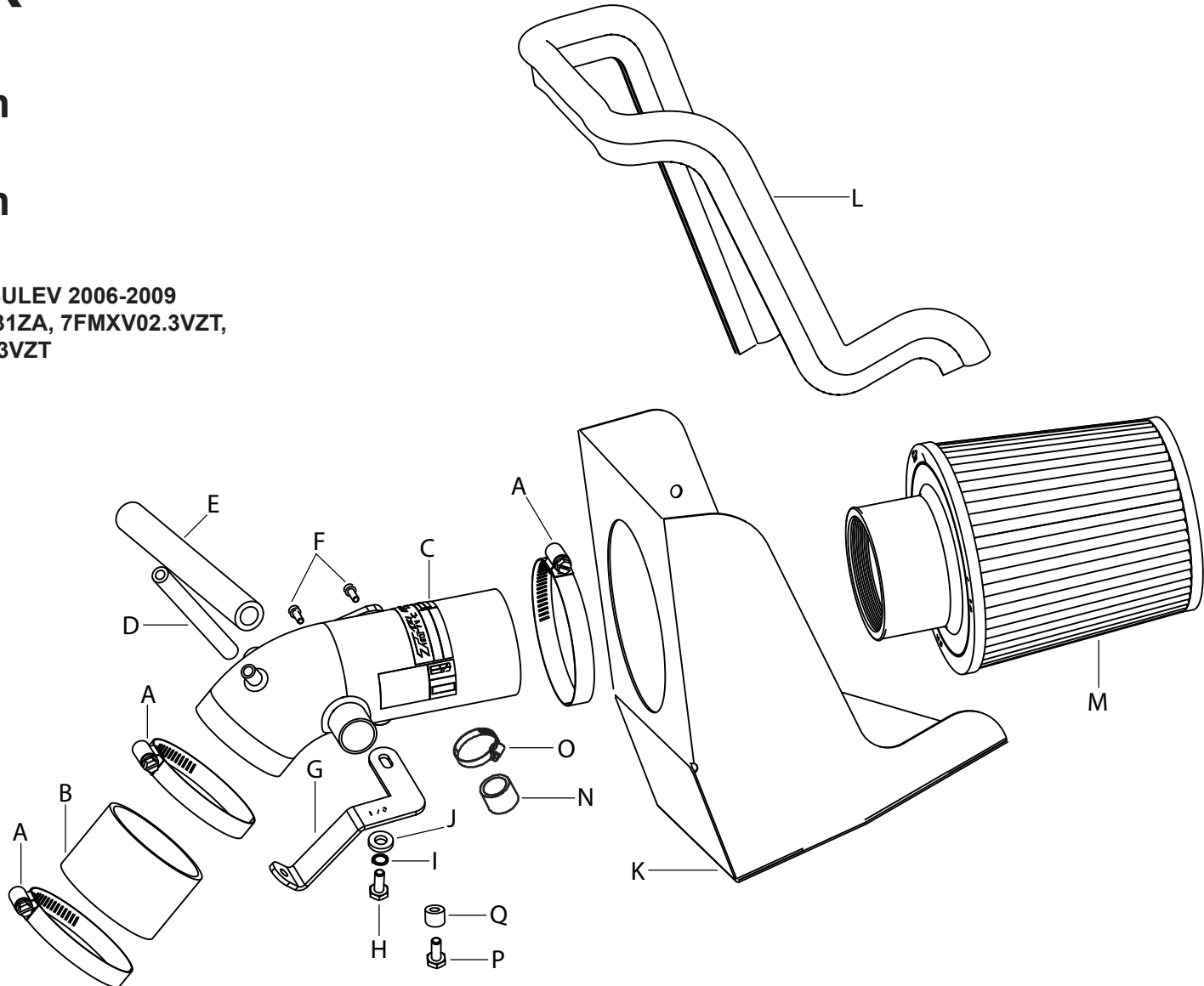

### PARTS LIST:

Description	Qty.	Part #	Description	Qty.	Part #	Description	Qty.	Part #
A Hose Clamp #44	3	08577	G Bracket; L, Stl., FB/PC	1	06491	M Air Filter	1	RU-4960
B Hose; 2-3/4" X 2" L, Blk.	1	08440	H Bolt; 6mm - 1.00 X 16mm, SS	1	07812	N Caplug	1	08246
C Intake Tube	1	27531	I Washer; 1/4" Lock, ZN	1	08198	O Hose Clamp #16	1	08413
D Hose; 8mm ID X 5" L	1	084076	J Washer; 1/4" ID X 5/8" OD	1	08275	P Bolt; M6 X 1.00" X 20mm Hex, SS	1	07795
E Hose 1/2" ID X 7"L, Blk.	1	08159	K Heat Shield	1	07654	Q Spacer: .625" OD X .250"ID X .250"L	1	06555
F Bolt; M4 - 0.07 8mm, A/H CAP, SS	2	07733	L Edge Trim	1	102496			

**NOTE: FAILURE TO FOLLOW INSTALLATION INSTRUCTIONS AND NOT USING THE PROVIDED HARDWARE MAY DAMAGE THE INTAKE TUBE, THROTTLE BODY AND ENGINE.**

### TO START:

1. Turn the ignition OFF and disconnect the vehicle's negative battery cable.  
**NOTE: Disconnecting the negative battery cable erases pre-programmed electronic memories. Write down all memory settings before disconnecting the negative battery cable. Some radios will require an anti-theft code to be entered after the battery is reconnected. The anti-theft code is typically supplied with your owner's manual. In the event your vehicles' anti-theft code cannot be recovered, contact an authorized dealership to obtain your vehicles anti-theft code.**

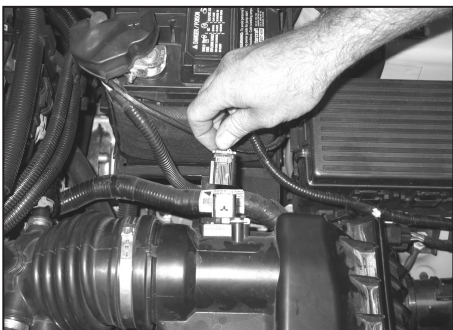

2. Release the red locking clip, then disconnect the mass air sensor electrical connection.



3. On vehicles equipped with an air injection pump, using pliers, release the spring clamp that fastens the air injection hose to the factory intake tube. Disconnect the air injection hose from the intake tube.



4. Release the spring clamp and then disconnect the solenoid valve hose from the stock plastic fitting.



5. Release the green locking ring, then disconnect the crank case vent hose from the stock intake tube.

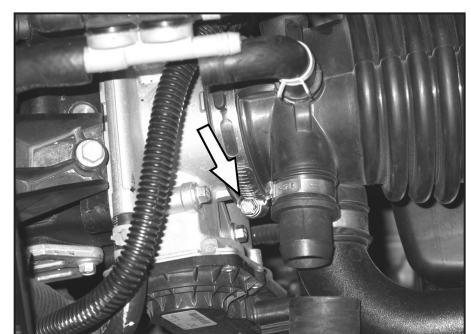

6. Loosen the hose clamp that fastens the stock intake tube to the throttle body.



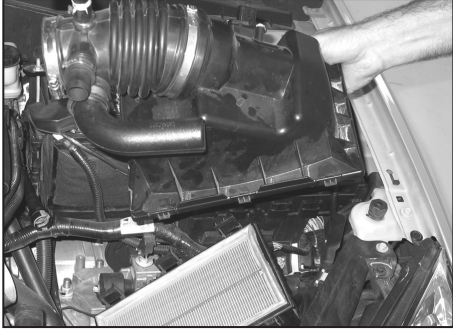

7. Release the three upper air box retaining clips, then remove the upper air box and intake tube assembly.



8. Firmly pull the lower air box upwards to dislodge it from the mounting grommets; remove the lower air box.

**NOTE: K&N Engineering, Inc., recommends that customers do not discard factory air intake.**

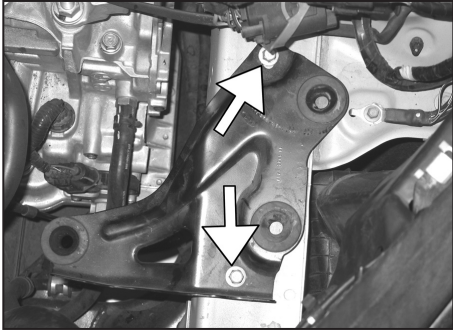

9. Remove the two bolts that fasten the air box mounting bracket to the inner fender, then remove the mounting bracket.

**NOTE: Mounting bolts will be re-used.**

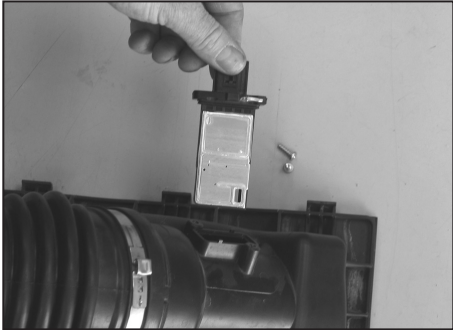

10. Remove the two screws that fasten the mass air sensor to the factory air box, then remove the mass air sensor.

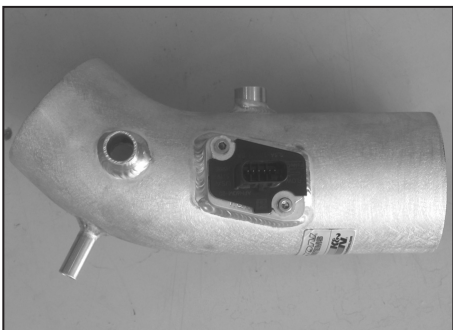

11. Install the mass air sensor into the K&N® intake tube using the provided hardware.



12. Disconnect the crank case vent hose from the valve cover and remove it. Place it on a surface suitable for cutting. Using a razor blade or knife, cut the crank case vent hose as shown.



13. Install the supplied silicone vent hose onto the cut end of the stock crank case vent hose.



14. Re-install the modified crank case vent hose and fasten using the stock retaining clip.



15. Install the provided edge trim onto the heat shield.

**NOTE: Some trimming of the edge trim will be needed.**



16. Place the heat shield into position in the inner fender well and fasten using the stock bolts removed in step # 9.



17. Install the provided silicone hose (08440) onto the throttle body and fasten using the provided hose clamp.

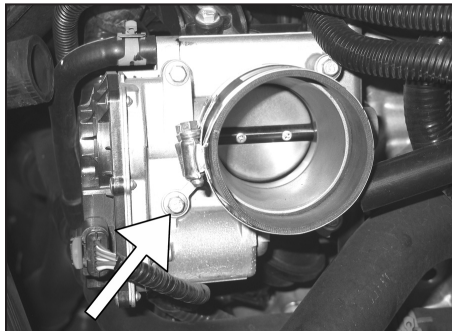

18. Remove the lower throttle body bolt.  
**NOTE: Bolt will be re-used.**

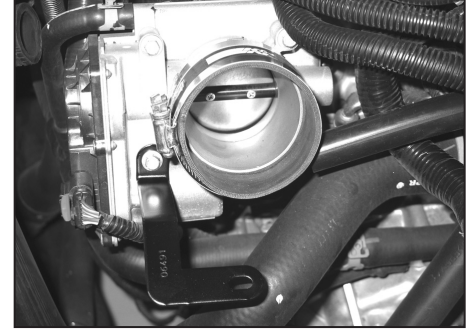

19. Install the intake tube mounting bracket and fasten using the factory bolt removed in step #18.



20. Install the K&N® intake tube into the silicone hose (08440) and align the tube mounting bracket (06491) with the intake tube fastening location. Secure the intake tube hose clamps and mounting bracket hardware.

**NOTE: On 2.5L engines, it will be necessary to use the provided spacer and longer bolt to secure the K&N® intake tube to the mounting bracket.**

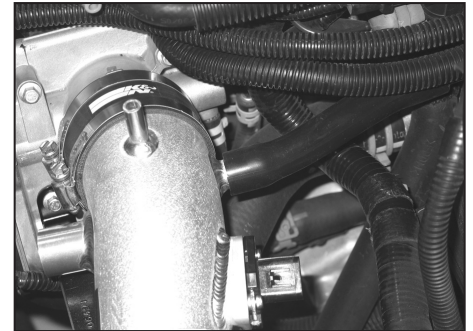

21. Connect the crank case vent hose to the K&N® intake tube.

**NOTE: Some trimming of the crank case vent hose may be necessary.**

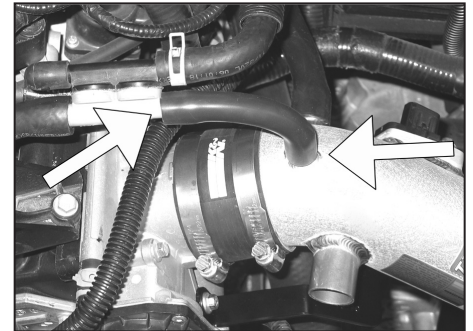

22. Connect the provided silicone solenoid valve hose to the stock fitting and K&N® intake tube fitting.

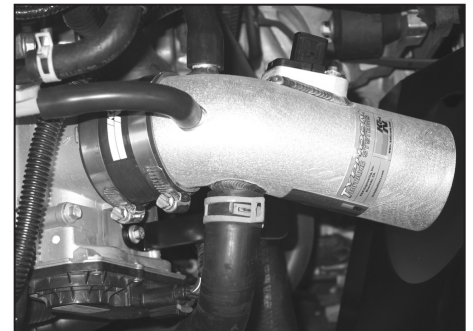

23. Connect the stock air injection hose to the fitting on the K&N® intake tube, then fasten using the stock spring clamp.

**NOTE: On vehicles not equipped with an air injection pump, install the supplied 1" I.D. black caplug to the fitting on the K&N® intake tube. Secure with the provided hose clamp.**





24. Install the K&N® air filter onto the intake tube and fasten using the provided hose clamp.

**NOTE: Drycharger® air filter wrap; part # RX-4990DK is available to purchase separately. To learn more about Drycharger® filter wraps or look up color availability please visit <http://www.knfilters.com>®.**

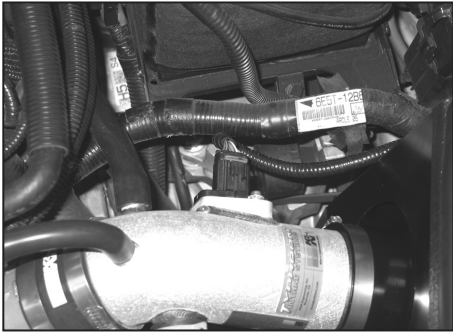

25. Re-connect the mass air sensor electrical connection.



26. Reconnect the vehicle's negative battery cable. Double check to make sure everything is tight and properly positioned before starting the vehicle.

27. The C.A.R.B. exemption sticker, (attached), must be visible under the hood so that an emissions inspector can see it when the vehicle is required to be tested for emissions. California requires testing every two years, other states may vary.

28. It will be necessary for all K&N® high flow intake systems to be checked periodically for realignment, clearance and tightening of all connections. Failure to follow the above instructions or proper maintenance may void warranty.

#### ROAD TESTING:

1. Start the engine with the transmission in neutral or park, and the parking brake engaged. Listen for air leaks or odd noises. For air leaks secure hoses and connections. For odd noises, find cause and repair before proceeding. This kit will function identically to the factory system except for being louder and much more responsive.

2. Test drive the vehicle. Listen for odd noises or rattles and fix as necessary.

3. If road test is fine, you can now enjoy the added power and performance from your kit.

4. K&N Engineering, Inc., requires cleaning the intake system's air filter element every 100,000 miles. When used in dusty or off-road environments, our filters will require cleaning more often. We recommend that you visually inspect your filter once every 25,000 miles to determine if the screen is still visible. When the screen is no longer visible some place on the filter element, it is time to clean it. To clean and re-oil, purchase our filter Recharger® service kit, part number 99-5050 or 99-5000 and follow the easy instructions.

**INTAKE SYSTEMS FOR VEHICLES LISTED ARE 50 STATE LEGAL. SEE KNFILTERS.COM FOR CARB STATUS ON EACH PART FOR A SPECIFIC VEHICLE.**