



TYPHOON INTAKE SYSTEMS

INTAKE SYSTEMS FOR VEHICLES LISTED ARE 50 STATE LEGAL. SEE KNFILTERS.COM FOR CARB STATUS ON EACH PART FOR A SPECIFIC VEHICLE.

INSTALLATION INSTRUCTIONS

69-3520TP
FORD / LINCOLN
2003-05 Thunderbird
2003-06 LS
V8-3.9L

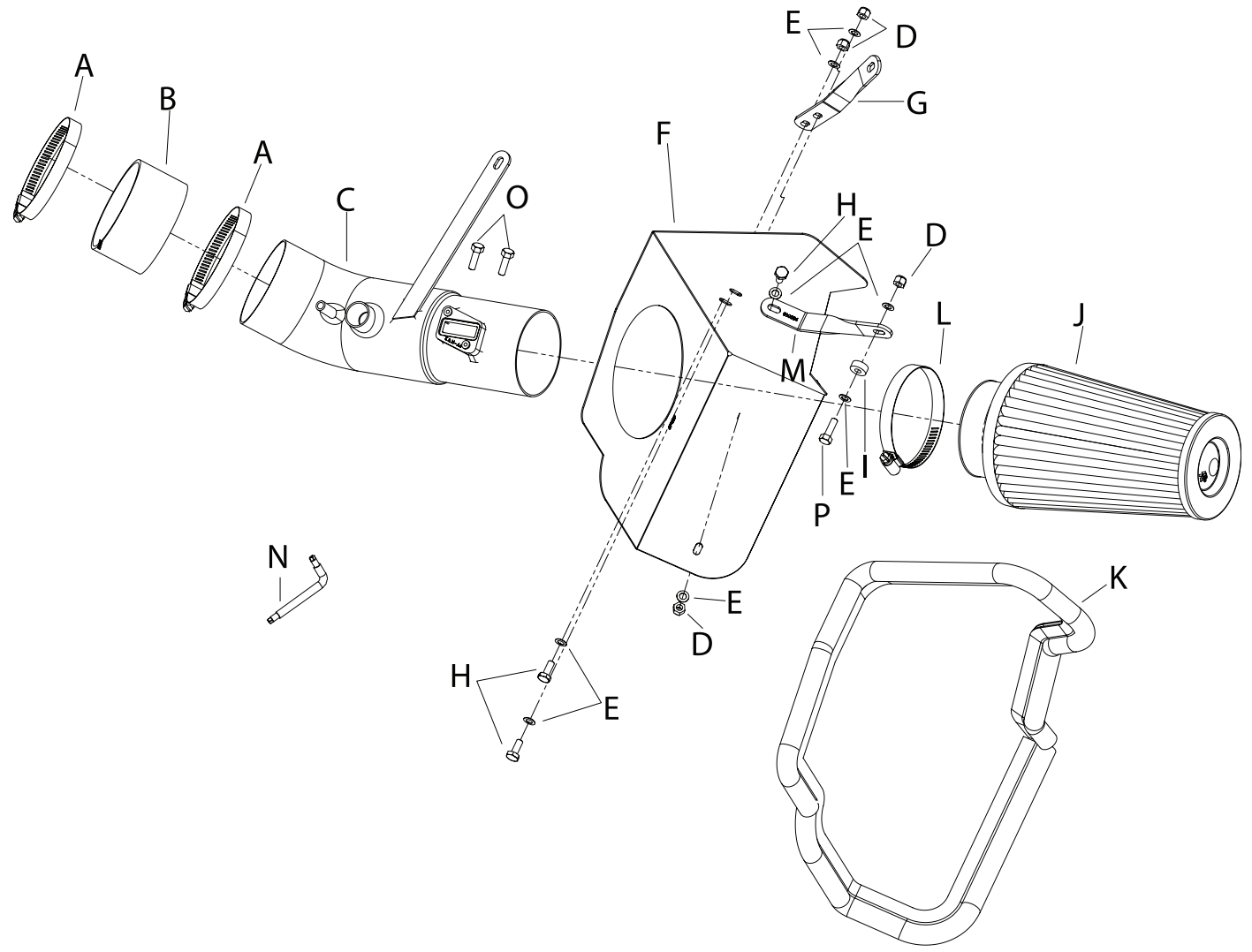

TOOLS NEEDED:

- Flat blade screw driver
- Ratchet
- Extension
- 8mm Socket
- 10mm Socket
- 11mm Socket
- 2.5mm Allen
- 10mm Wrench

PARTS LIST:

Description	Qty.	Part #	Description	Qty.	Part #	Description	Qty.	Part #
A HOSE CLAMP #60	2	08628	G BRACKET, TWISTED "L"	1	010084	M BRACKET; TWISTED "C"	1	010083
B HOSE; 3-1/2"ID X 2"L,	1	08698	H BOLT; 6MM X 16, SS	3	07812	N WRENCH T20 TORX	1	69801
C INTAKE TUBE	1	27321	I SPACER; ALUMINUM	1	06555	O SCREW; M4	2	07726
D NUT; 6MM NYLOCK, SS	4	07512	J AIR FILTER	1	RU-5122	P BOLT; 6mm X 20, SS	1	07795
E WASHER; 6MM WAVE	8	08277	K EDGE TRIM, 50" L	1	102481			
F HEAT SHIELD	1	07489	L HOSE CLAMP #60	1	08624			

NOTE: FAILURE TO FOLLOW INSTALLATION INSTRUCTIONS AND NOT USING THE PROVIDED HARDWARE MAY DAMAGE THE INTAKE TUBE, THROTTLE BODY AND ENGINE.

TO START:

1. Turn off the ignition and disconnect the negative battery cable.
NOTE: Disconnecting the negative battery cable erases pre-programmed electronic memories. Write down all memory settings before disconnecting the negative battery cable. Some radios will require an anti-theft code to be entered after the battery is reconnected. The anti-theft code is typically supplied with your owner's manual. In the event your vehicles' anti-theft code cannot be recovered, contact an authorized dealership to obtain your vehicles anti-theft code.

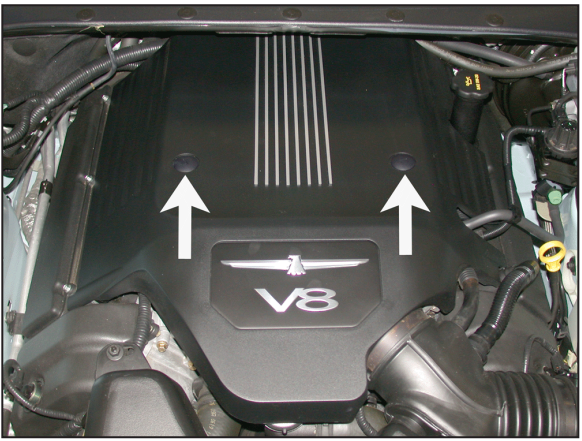

2. Remove the two plastic screws shown securing the engine cover.



3. Pull up on the rear of the engine cover to dislodge from the retaining mounts, and then remove the engine cover from the engine.

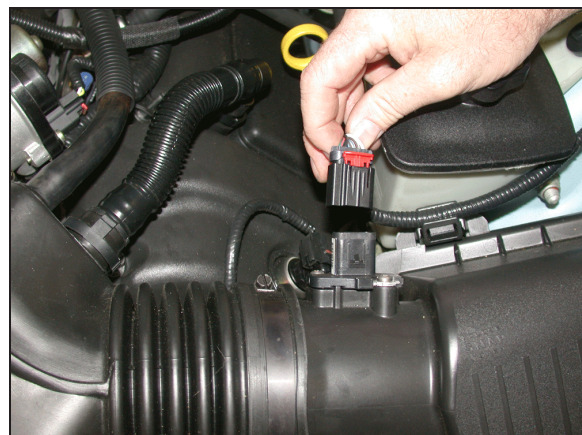

4. Pull back the red locking tab on the mass air sensor electrical connection, and then disconnect the mass air sensor electrical connection.

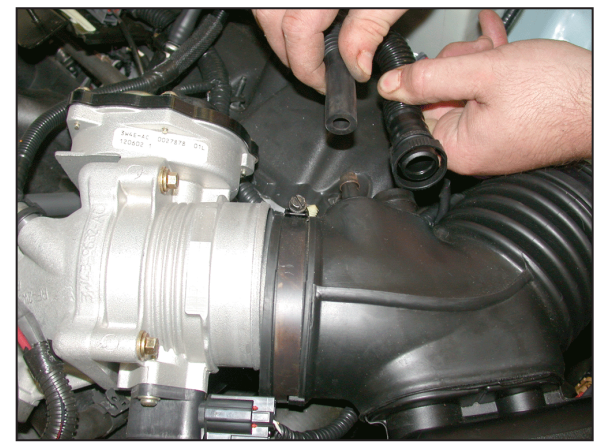

5. Disconnect the hoses from the stock intake tube as shown.

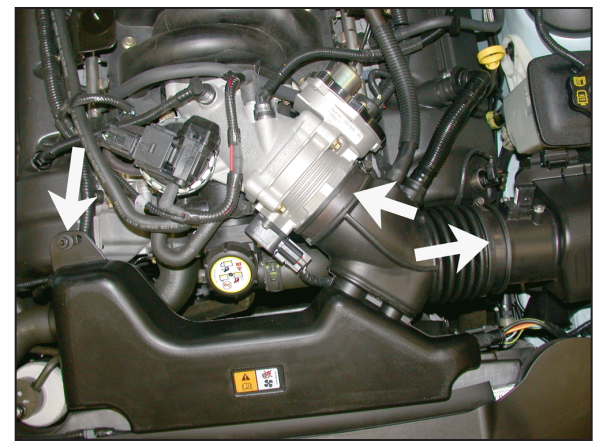

6. Loosen the hose clamps at the throttle body and the factory air box, and then remove the intake tube retaining nut shown.



7. Remove the stock intake tube assembly from the vehicle.



8. Remove the air box retaining bolt shown.

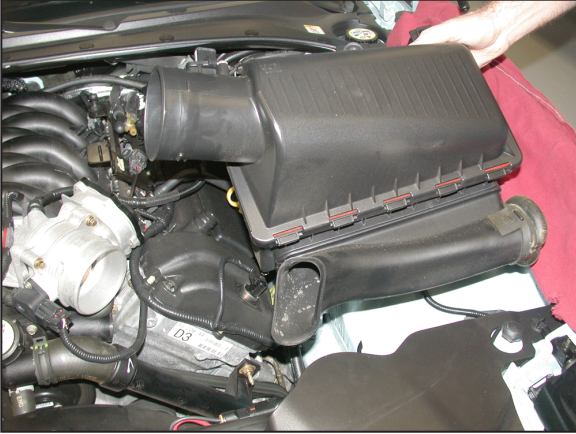

9. Pull up firmly on the air box to dislodge it from the retaining pin, and then remove the air box from the vehicle.

NOTE: K&N Engineering, Inc., recommends that customers do not discard factory air intake.



10. Install the provided edge trim onto the heat shield as shown.



11. Install the heat shield mounting bracket (010083) onto the heat shield as shown with the provided hardware.

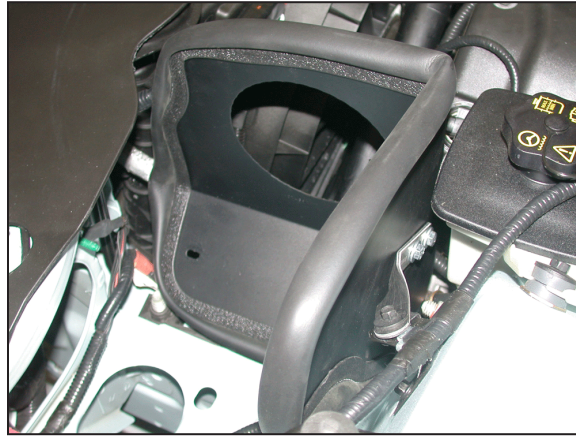

12. Install the heat shield into the vehicle and secure the bracket to the factory air box mount with the factory bolt removed in step #8.



13. Install the provided 6mm bolt through the factory hole in the core support and then install the provided spacer onto the bolt as shown.



14. Install the provided heat shield bracket (010084) onto the bolt installed in step #14, and then fasten the bracket to the heat shield with the provided hardware.

NOTE: Use the supplied 1/4" washer as a spacer between the bracket and heat shield.



15. Install the provided silicone hose (08698) onto the throttle body and secure with the provided hose clamp.



16. Using the "TORX" wrench provided, remove the mass air sensor from the air box lid as shown.

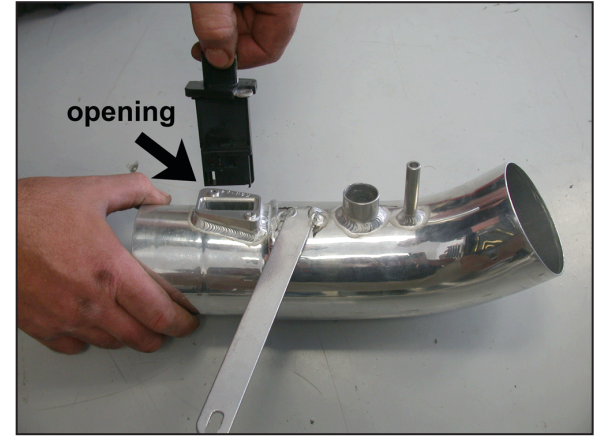

17. Install the mass air assembly into the intake tube and secure with the provided hardware.
NOTE: Be sure to install with the opening of the mass air sensor towards the filter end of the tube as shown.



18. Install the intake tube assembly into the silicone hose at the throttle body and slide the bracket onto the stock bolt as shown.

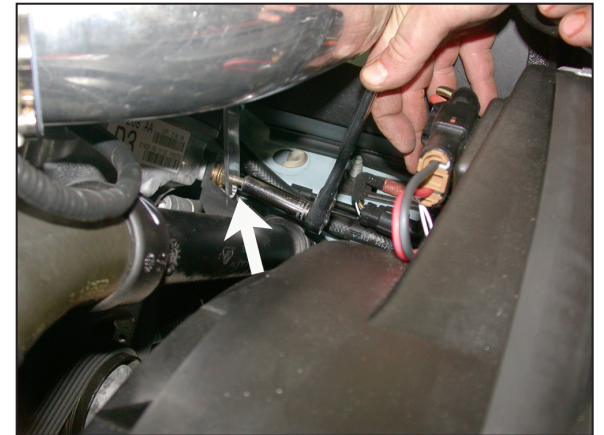

19. Secure the bracket using the provided hardware as shown.

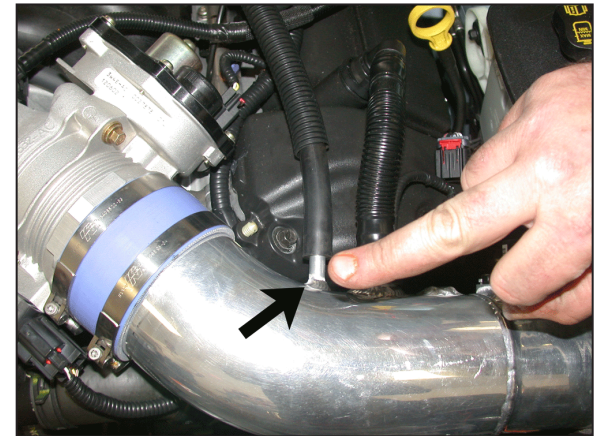

20. Install the small vent hose onto the intake tube as shown.

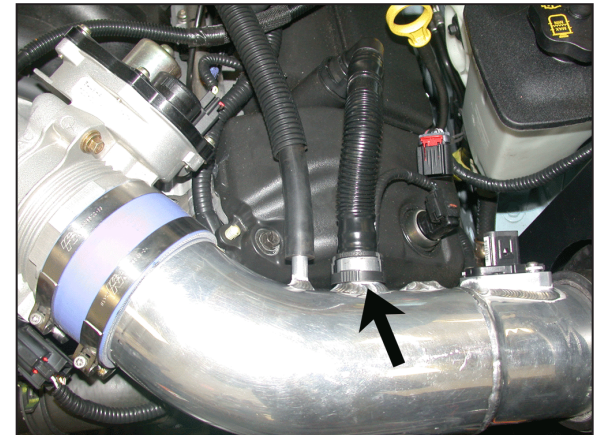

21. Install the large vent hose onto the intake tube as shown.



22. Install the air filter and secure with the provided hose clamp.

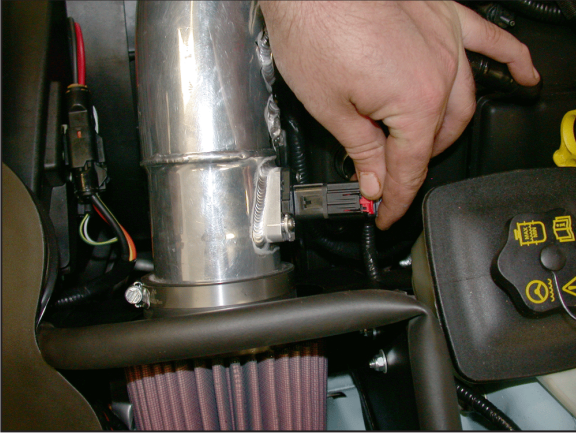

23. Reconnect the mass air sensor electrical connection.

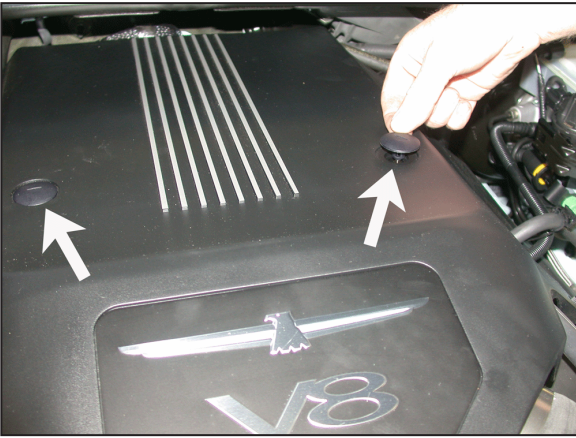

24. Reinstall the engine cover onto the rear retaining clips and then reinstall the retaining clips removed in step #2.



25. Reconnect the vehicle's negative battery cable. Double check to make sure everything is tight and properly positioned before starting the vehicle.

26. The C.A.R.B. exemption sticker, (attached), must be visible under the hood, so the emissions inspector can see it when the vehicle is required to be tested for emissions. California requires testing every two years, other states may vary.

27. It will be necessary for all K&N® high flow intake systems to be checked periodically for realignment, clearance and tightening of all connections. Failure to follow the above instructions or proper maintenance may void warranty.

ROAD TESTING:

1. Start the engine with the transmission in neutral or park, and the parking brake engaged. Listen for air leaks or odd noises. For air leaks secure hoses and connections. For odd noises, find cause and repair before proceeding. This kit will function identically to the factory system except for being louder and much more responsive.

2. Test drive the vehicle. Listen for odd noises or rattles and fix as necessary.

3. If road test is fine, you can now enjoy the added power and performance from your kit.

4. K&N Engineering, Inc., requires cleaning the intake system's air filter element every 100,000 miles. When used in dusty or off-road environments, our filters will require cleaning more often. We recommend that you visually inspect your filter once every 25,000 miles to determine if the screen is still visible. When the screen is no longer visible some place on the filter element, it is time to clean it. To clean and re-oil, purchase our filter Recharger® service kit, part number 99-5050 or 99-5000 and follow the easy instructions.

INTAKE SYSTEMS FOR VEHICLES LISTED ARE 50 STATE LEGAL. SEE KNFILTERS.COM FOR CARB STATUS ON EACH PART FOR A SPECIFIC VEHICLE.