



TYPHOON INTAKE SYSTEMS

INTAKE SYSTEMS FOR VEHICLES LISTED ARE 50 STATE LEGAL. SEE KNFILTERS.COM FOR CARB STATUS ON EACH PART FOR A SPECIFIC VEHICLE.

INSTALLATION INSTRUCTIONS

69-3533TTK
FORD
2014 Fusion
L4-2.5L

TOOLS NEEDED:

- Flat blade screw driver
- T20 TORX
- 3mm allen
- 3/4" wrench
- 9/16" wrench

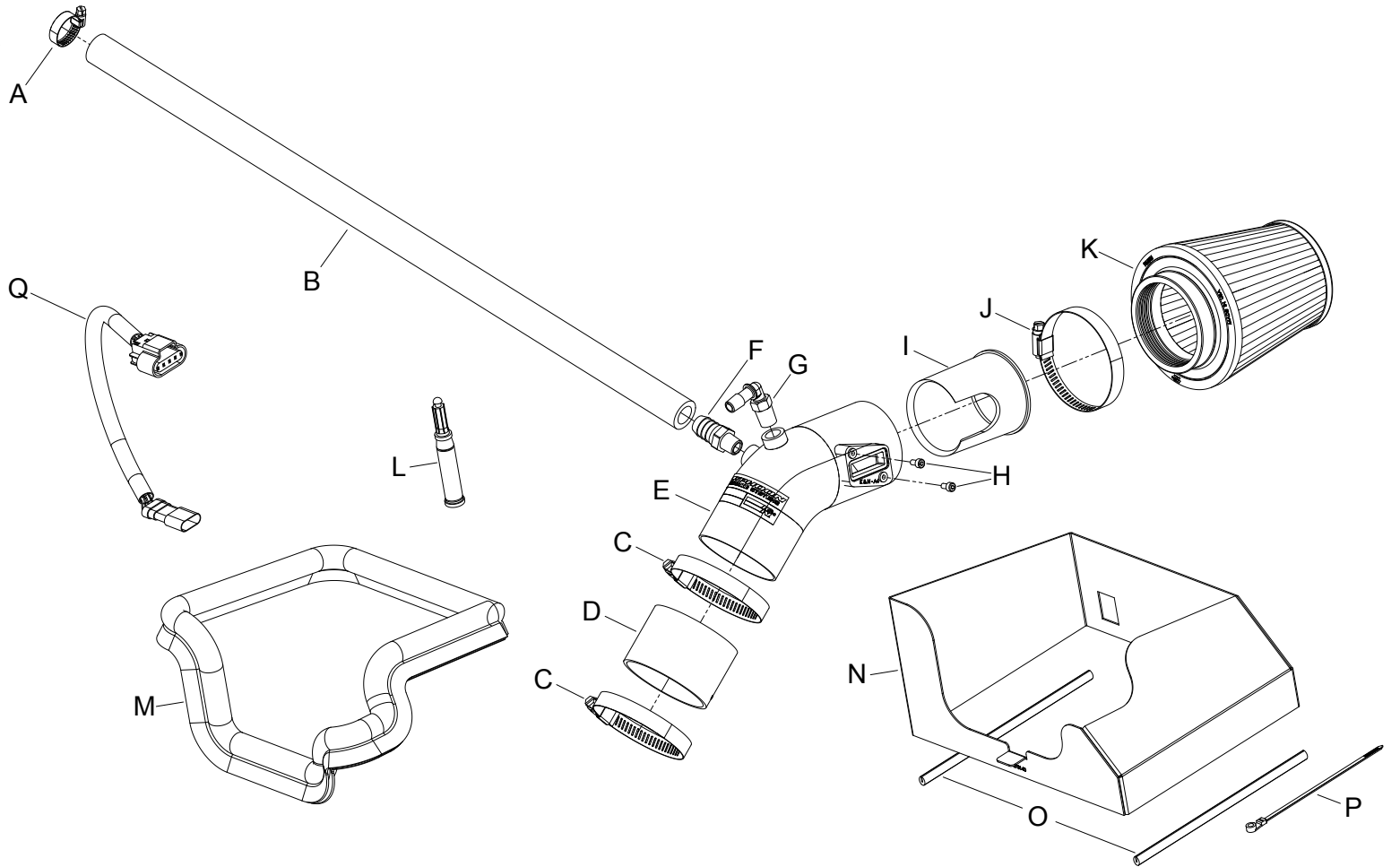

PARTS LIST:

Description	Qty.	Part #	Description	Qty.	Part #	Description	Qty.	Part #
A HOSE CLAMP #10 MINI	1	08411	G VENT; 1/4NPT, 90 DEG, 3/8"	1	08523	M EDGE TRIM (25")	1	102471
B RUBBER HOSE; 5/8"ID X 25"L	1	5-7025	H BOLT; M4-0.07 8MM, A/H CAP	2	07733	N HEAT SHIELD	1	073140
C HOSE CLAMP #44 STAINLESS	2	08560	I VENTURI; 2.5"OD X 2.25"ID	1	9-479	O EDGE TRIM (19")	1	102451
D HOSE; 2-3/4" ID X 2"L	1	08440	J HOSE CLAMP #44	1	08577	P CABLE TIE; 6", BLACK	1	21595
E INTAKE TUBE	1	27339TK	K AIR FILTER	1	RC-9350	Q MAD EXTENSION HARNESS	1	21780
F VENT; STRT, 5/8 BARBED 1/4	1	08911	L SUPER GLUE, 3G DRIP PROOF	1	409			

NOTE: FAILURE TO FOLLOW INSTALLATION INSTRUCTIONS AND NOT USING THE PROVIDED HARDWARE MAY DAMAGE THE INTAKE TUBE, THROTTLE BODY AND ENGINE.

TO START:

1. Turn off the ignition and disconnect the negative battery cable.
NOTE: Disconnecting the negative battery cable erases pre-programmed electronic memories. Write down all memory settings before disconnecting the negative battery cable. Some radios will require an anti-theft code to be entered after the battery is reconnected. The anti-theft code is typically supplied with your owner's manual. In the event your vehicles anti-theft code cannot be recovered, contact an authorized dealership to obtain your vehicles anti-theft code.

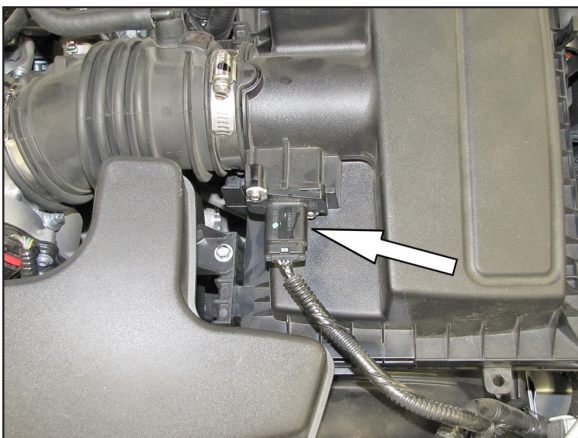

2. Disconnect the mass air sensor electrical connection.

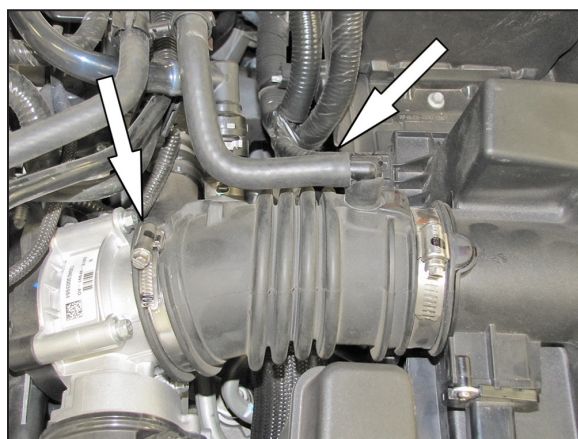

3. Disconnect the EVAP vent hose from the factory 90° fitting and then loosen the hose clamp securing the factory intake hose to the throttle body.

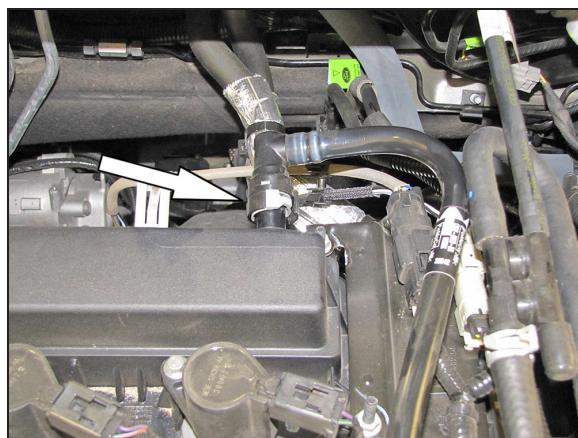

4. Disconnect the crank case vent hose from the valve cover.

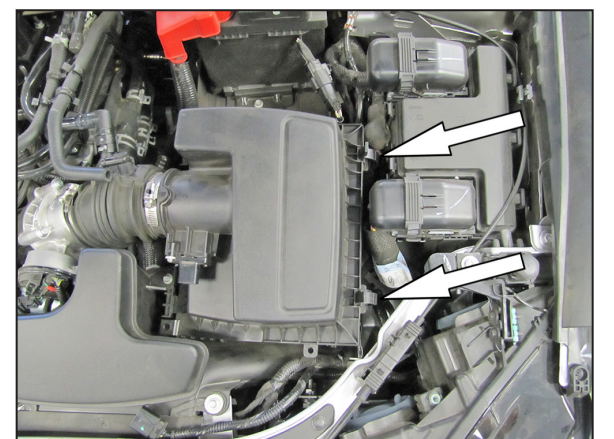

5. Release the two upper housing clips and then remove the upper housing, intake hose and air filter from the vehicle.

NOTE: K&N Engineering, Inc., recommends that customers do not discard factory air intake.

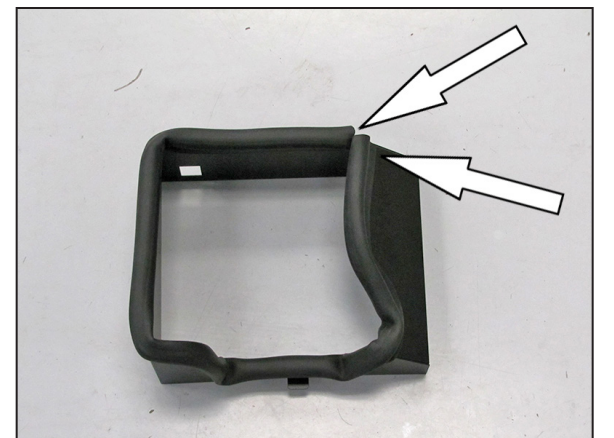

6. Install the provided top bulb edge trim onto the heat shield as shown.

NOTE: Some trimming of the edge trim will be necessary.

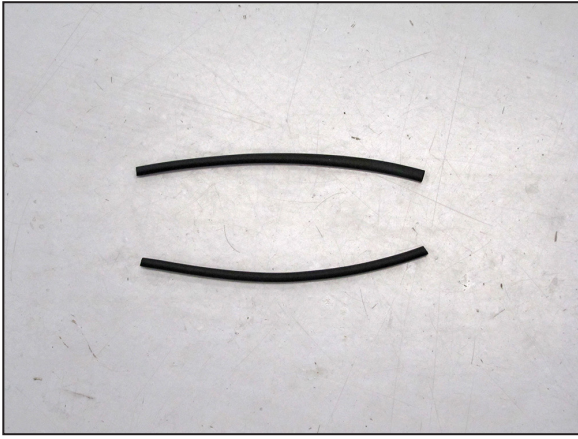

7. Cut the provided small edge trim in half as shown.

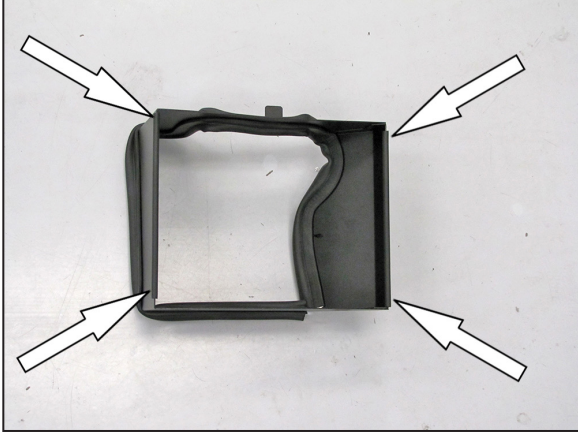

8. Install the two small edge trim sections onto the bottom of heat shield as shown.

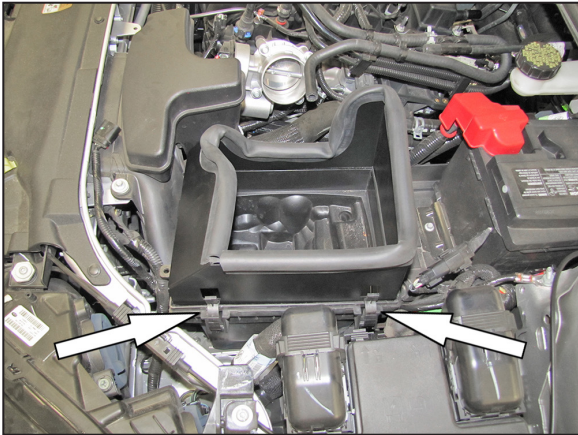

9. Install the heat shield onto the lower air box housing and secure with the factory retaining clips.

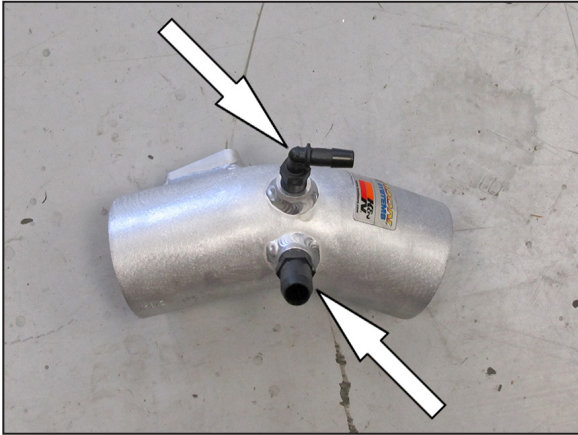

10. Install the two provided vent fittings into the K&N® intake tube as shown.

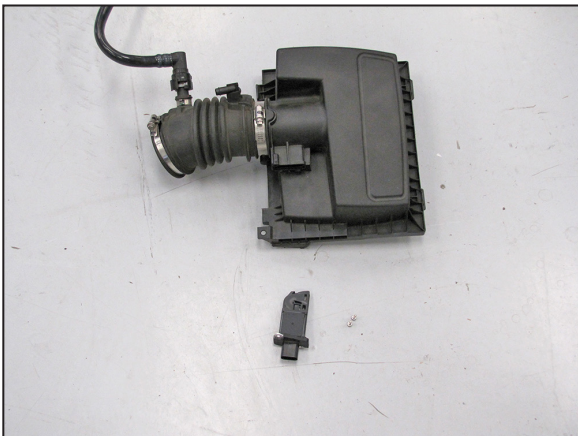

11. Remove the two screws securing the mass air sensor into the upper air box housing and then remove the sensor from the housing.



12. Install the Mass air sensor into the K&N® intake tube and secure with the provided hardware.

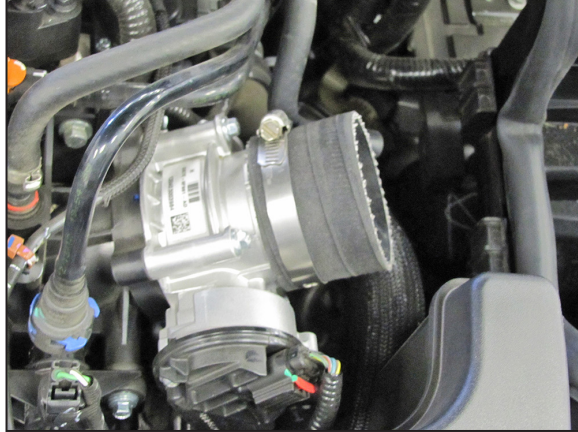

13. Install the provided silicone hose (08440) onto the throttle body and secure with the provided hose clamps.



14. Apply several drops of the provided glue to the lip of the venturi insert as shown.

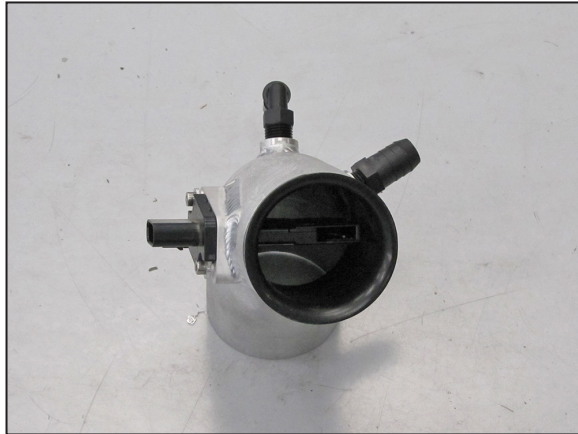

15. Install the venturi into the K&N® intake tube as shown.

NOTE: The cut-out section of the mass air sensor will align with the mass air sensor.



16. Install the K&N® air filter onto the K&N® intake tube and secure with the provided hose clamp.

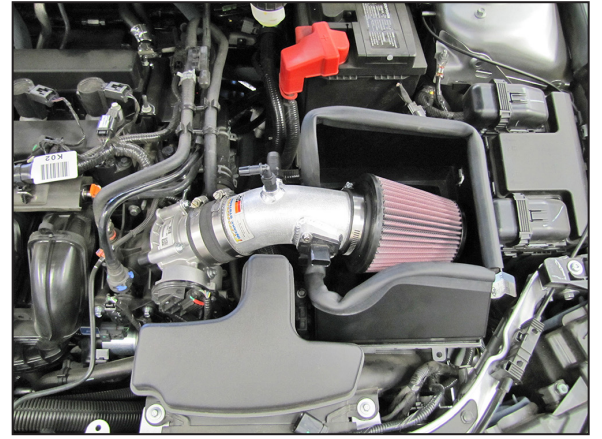

17. Install the Intake tube assembly into the silicone hose at the throttle body as shown, align for best fit and then secure with the provided hose clamp.

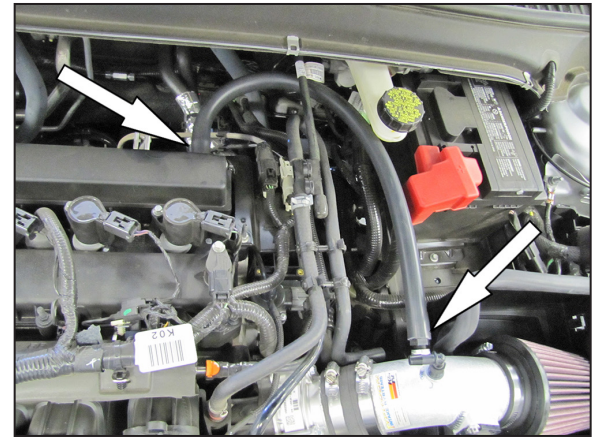

18. Install the provided crankcase vent hose onto the valve cover port and then onto the fitting installed into the K&N® intake tube as shown. **NOTE: Some trimming of the hose may be necessary.**

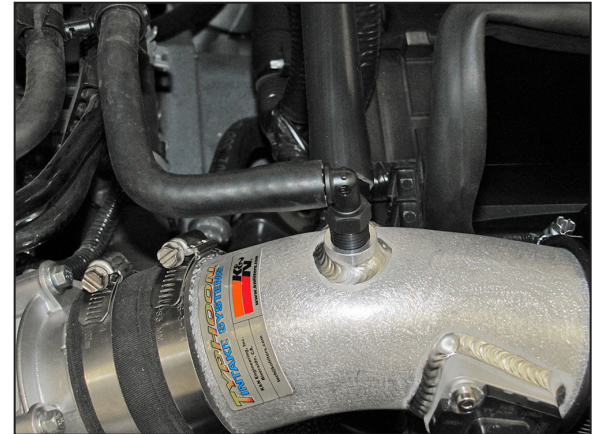

19. Connect the EVAP vent line to the 90° fitting installed into the K&N® intake tube as shown.

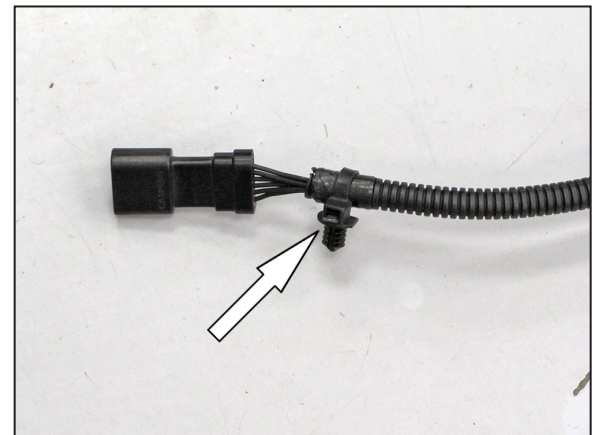

20. Install the provided "Mounting Tie Wrap" onto the female end of the mass air extension harness as shown.

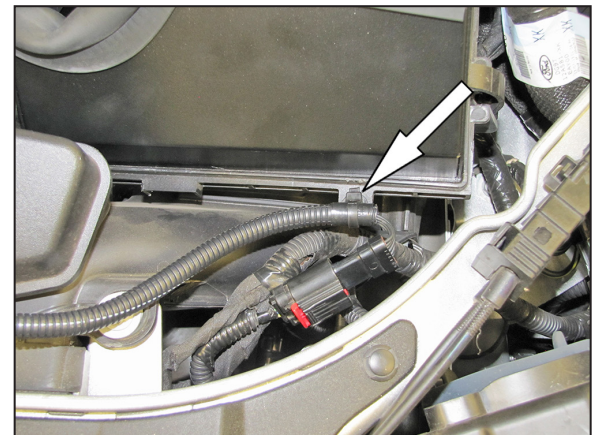

21. Connect the extension harness into the factory harness and then secure the harness to the lower air housing with the mounting tie wrap as shown.

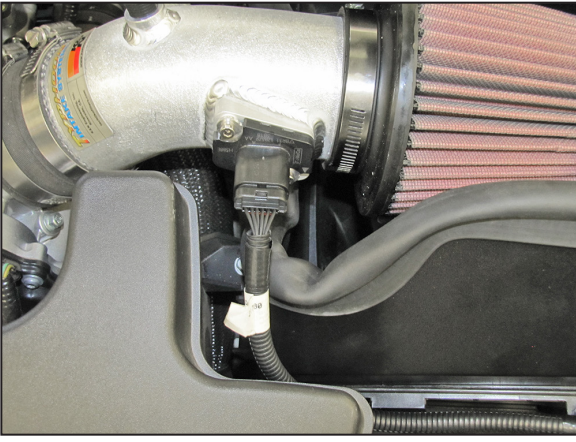

22. Connect the open end of the harness to the mass air sensor as shown.

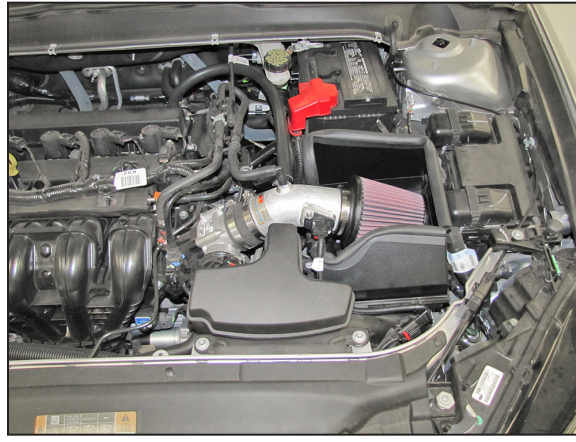

23. Reconnect the vehicle's negative battery cable. Double check to make sure everything is tight and properly positioned before starting the vehicle.

24. The C.A.R.B. exemption sticker, (attached), must be visible under the hood so that an emissions inspector can see it when the vehicle is required to be tested for emissions. California requires testing every two years, other states may vary.

25. It will be necessary for all K&N® high flow intake systems to be checked periodically for realignment, clearance and tightening of all connections. Failure to follow the above instructions or proper maintenance may void warranty.

ROAD TESTING:

1. Start the engine with the transmission in neutral or park, and the parking brake engaged. Listen for air leaks or odd noises. For air leaks secure hoses and connections. For odd noises, find cause and repair before proceeding. This kit will function identically to the factory system except for being louder and much more responsive.

2. Test drive the vehicle. Listen for odd noises or rattles and fix as necessary.

3. If road test is fine, you can now enjoy the added power and performance from your kit.

4. K&N Engineering, Inc., requires cleaning the intake system's air filter element every 100,000 miles. When used in dusty or off-road environments, our filters will require cleaning more often. We recommend that you visually inspect your filter once every 25,000 miles to determine if the screen is still visible. When the screen is no longer visible some place on the filter element, it is time to clean it. To clean and re-oil, purchase our filter Recharger® service kit, part number 99-5050 or 99-5000 and follow the easy instructions.

INTAKE SYSTEMS FOR VEHICLES LISTED ARE 50 STATE LEGAL. SEE KNFILTERS.COM FOR CARB STATUS ON EACH PART FOR A SPECIFIC VEHICLE.