



TYPHOON INTAKE SYSTEMS

INTAKE SYSTEMS FOR VEHICLES LISTED ARE 50 STATE LEGAL. SEE KNFILTERS.COM FOR CARB STATUS ON EACH PART FOR A SPECIFIC VEHICLE.

INSTALLATION INSTRUCTIONS

69-5305TP
KIA
2005-08 Spectra
L4-2.0L

TOOLS NEEDED:

- Flat Blade Screwdriver
- 10mm Socket
- 12mm Socket
- 1/4" Ratchet Extensions
- 4mm Allen
- Pliers

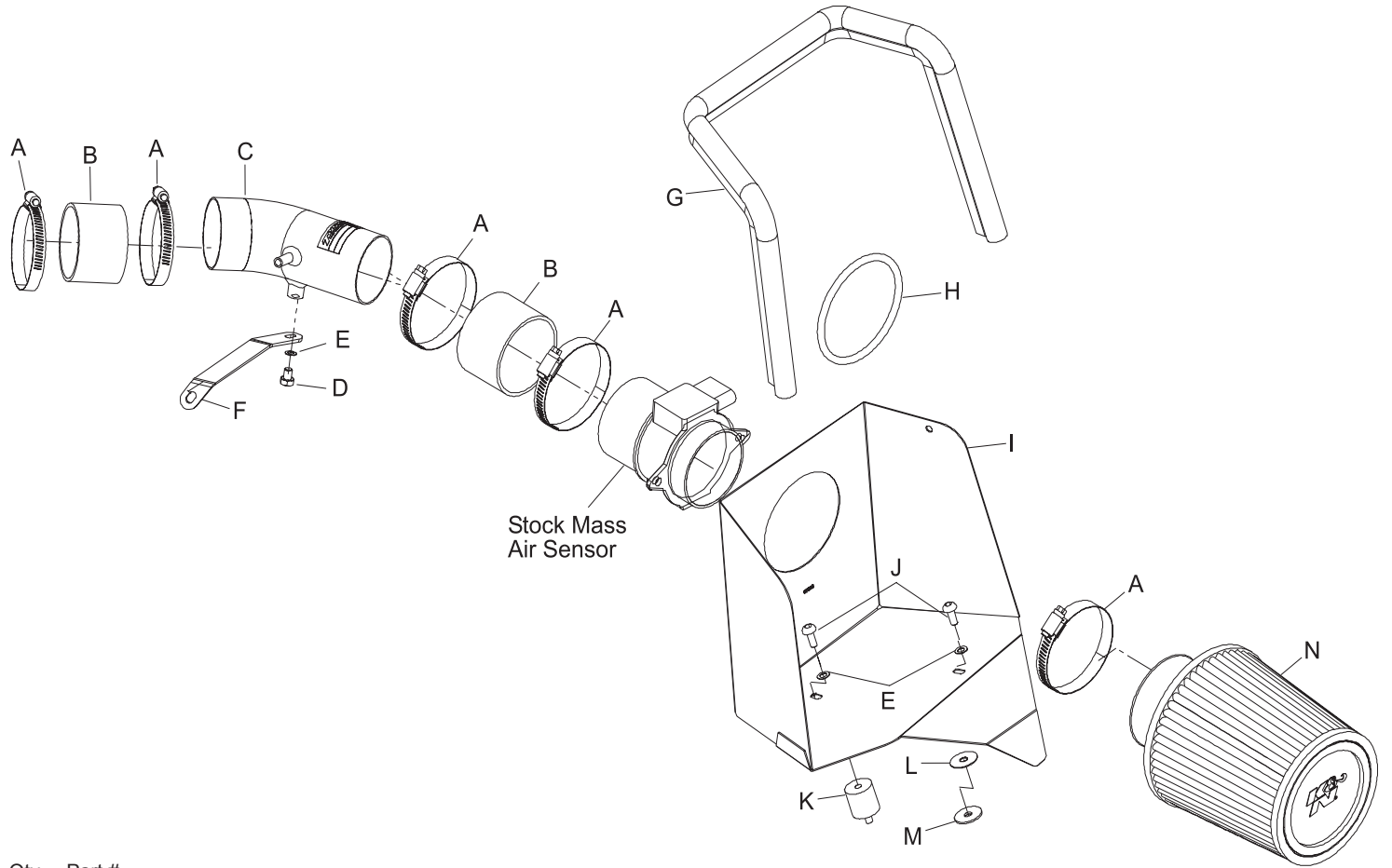

PARTS LIST:

Description	Qty.	Part #	Description	Qty.	Part #	Description	Qty.	Part #
A Hose Clamp #44	5	08577	F Bracket, C, Stl, FB/PC	1	020007	K Stud; Mount, M6 x 1, 1" T, M/F	1	02033
B Hose 2-3/4" x 2"L	2	08440	G Edge Trim 30"L	1	102489	L Washer 1"D x 1/4 Hole Fender	1	08160
C Tube,	1	27510	H Edge Trim 1/16"Gap, 12"L	1	102466	M Washer 1" x .300 x .100 Rubber	1	21685
D Bolt 6mm-1.00 x 12mm Hex.	1	07812	I Heat Shield, Stl,	1	07338	N Air Filter	1	RU-4870
E Washer 6mm Wave, SS	3	08277	J Bolt M6x1.00x16mm, Bttnhd, SS	2	07730			

NOTE: FAILURE TO FOLLOW INSTALLATION INSTRUCTIONS AND NOT USING THE PROVIDED HARDWARE MAY DAMAGE THE INTAKE TUBE, THROTTLE BODY AND ENGINE.

TO START:

1. Turn off the ignition and disconnect the negative battery cable.

NOTE: Disconnecting the negative battery cable erases pre-programmed electronic memories. Write down all memory settings before disconnecting the negative battery cable. Some radios will require an anti-theft code to be entered after the battery is reconnected. The anti-theft code is typically supplied with your owner's manual. In the event your vehicles' anti-theft code cannot be recovered, contact an authorized dealership to obtain your vehicles anti-theft code.

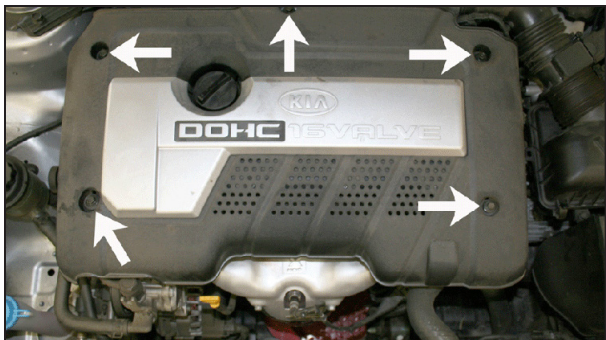

2. Remove the engine cover by loosening the 5 mounting bolts.



3. Unclip the mass air sensor electrical connection as shown.



4. Unclip the mass air sensor electrical harness from the factory intake tube.

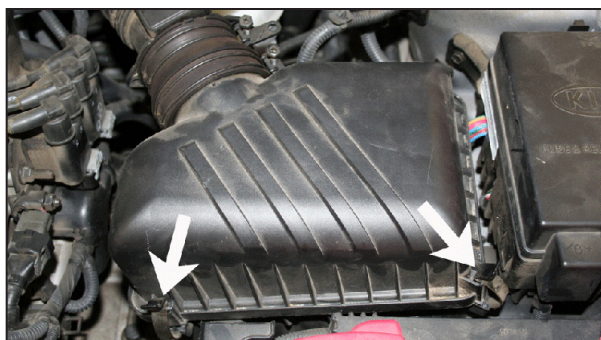

5. Unfasten the two clips that secure the airbox lid.

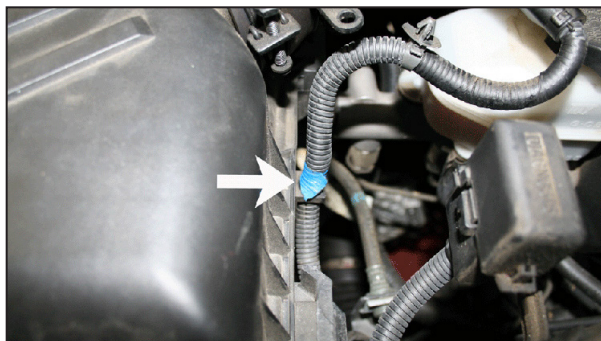

6. Unclip the mass air sensor electrical harness from airbox.



7. Loosen the hose clamp securing the factory intake tube to the throttle body.

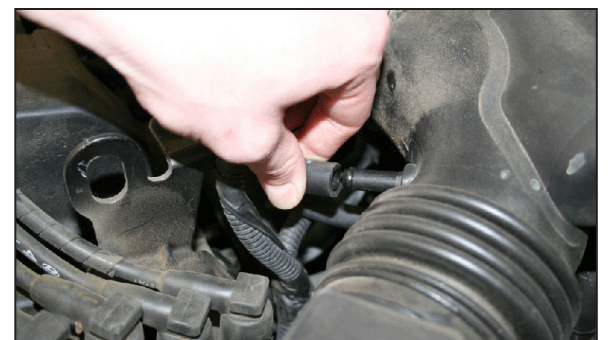

8. Disconnect the crankcase vent hose from the stock intake tube.

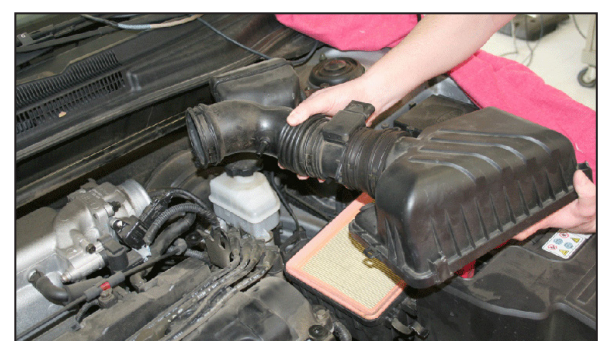

9. Remove the factory intake tube and the airbox lid from the vehicle.

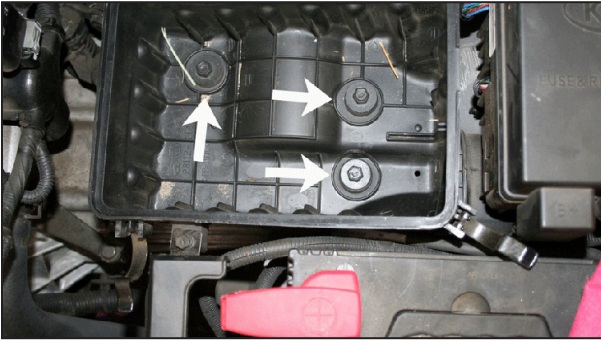

10. Loosen the three bolts that secure the lower airbox to the vehicle.

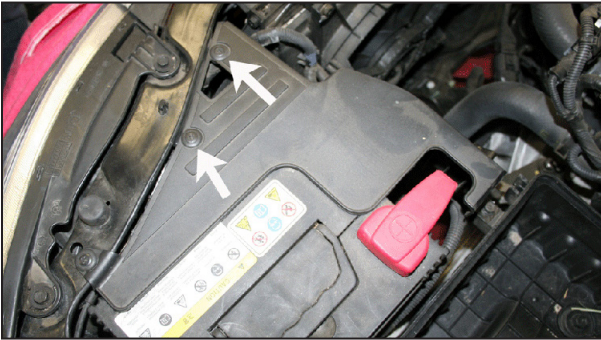

11. Remove the three screw style clips and one bolt that secure the battery cover.



12. Remove the battery cover as shown.

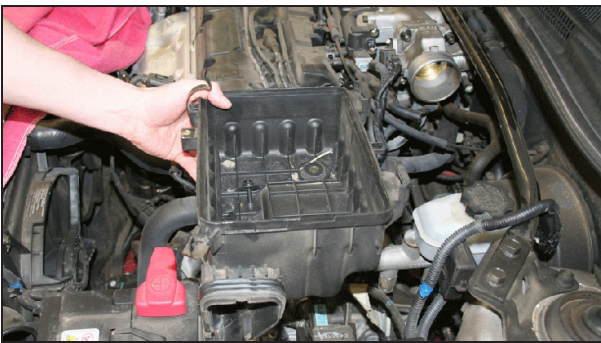

13. Remove the lower airbox as shown.
NOTE: K&N Engineering, Inc., recommends that customers do not discard factory air intake.



14. Separate the factory mass air flow sensor from the airbox lid and factory tube by loosening the two clamps.

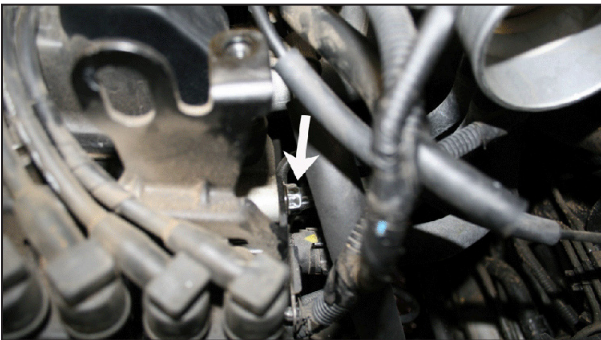

15. Remove the engine hoist bracket bolt and set aside, it will be reused at a later time.



16. Install the provided "C" bracket onto the intake tube and secure it with the provided hardware.
NOTE: Before installing the bracket, inspect the inside of the tube for any debris, then clean the inside out with water and a towel. Inspect the tube one more time before proceeding to the next step.



17. Install the mass air sensor onto the the intake tube with the silicone hose and two hose clamps. Tighten the hose clamps at this time.

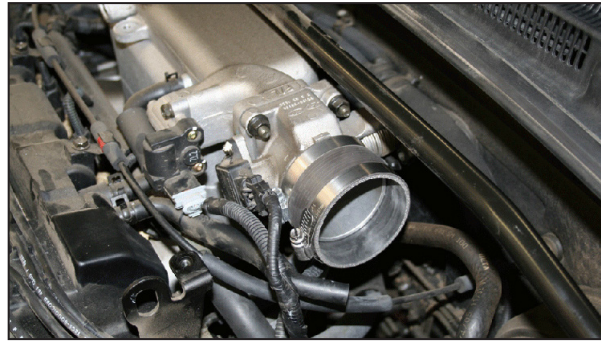

18. Install the provided silicone hose and hose clamps onto the throttle body. Secure the hose clamp on the throttle body at this time.



19. Install the provided edge trim onto heat shield as shown.



20. Install the provided small edge trim onto the filter opening of the heat shield as shown.

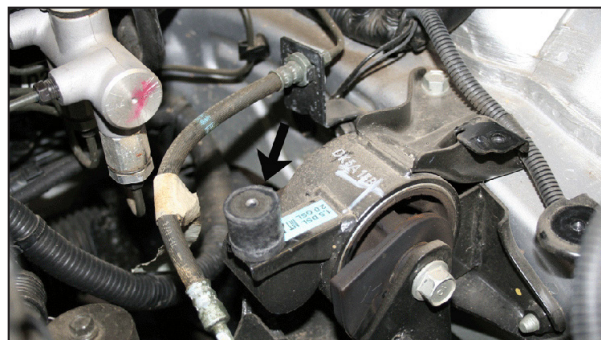

21. Install the 1" rubber mounted stud (02033) onto the stock airbox mounting hole, the mounting hole located closest to the engine.

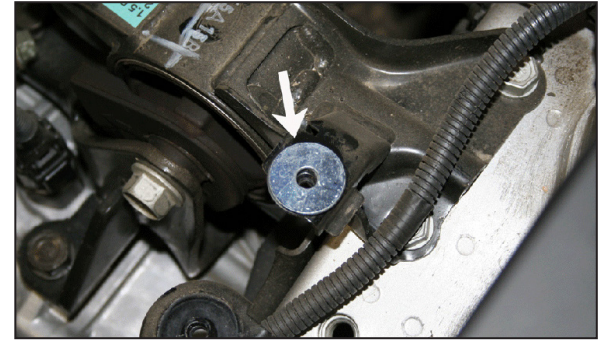

22. Place the rubber washer and fender washer onto the stock airbox mounting hole on the transmission mount as shown.

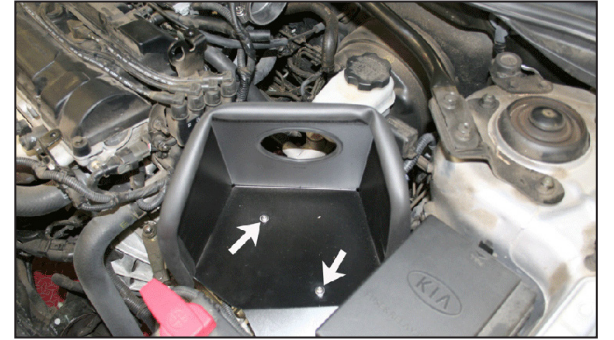

23. Install the heat shield, aligning the rear mounting hole with rubber mounted stud installed in step #21. Align the 2nd mounting hole with the mounting location the fender washers were placed in during step #22. Secure the heat shield in place with the provided hardware.

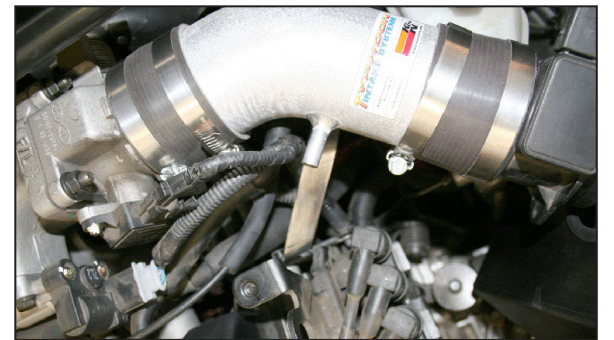

24. Install the intake tube onto the throttle body silicone hose and align the bracket with the bolt hole exposed in step #15. Reinstall the bolt removed in step #15, but do not completely tighten at this time.



25. Remove the hose clamp from the air filter as shown.
NOTE: Drycharger® air filter wrap; part # RX-4730DK is available to purchase separately. To learn more about Drycharger® filter wraps or look up color availability please visit <http://www.knfilters.com>®.



26. Attach the air filter onto the mass air flow sensor, ensuring the air filter hose clamp is installed from behind the heat shield, closest to mass air flow sensor.

27. Tighten all loose bolts and hardware at this time.

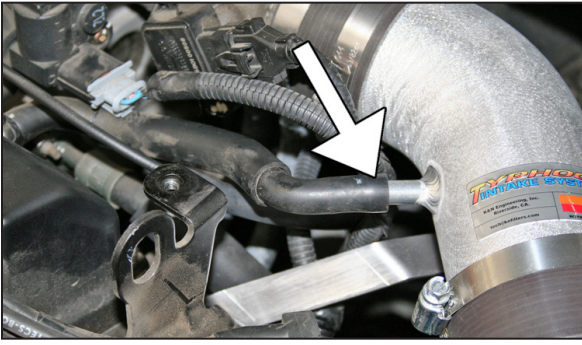

28. Install the crankcase vent hose onto the intake tube.

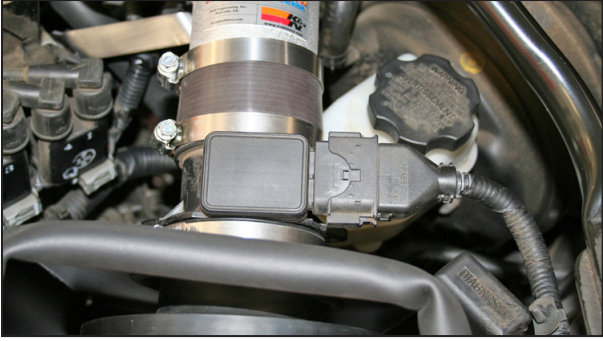

29. Reconnect the mass air flow sensor electrical connection.



30. Reinstall the engine cover.



31. Reconnect the vehicle's negative battery cable. Double check to make sure everything is tight and properly positioned before starting the vehicle.

32. It will be necessary for all K&N® high flow intake systems to be checked periodically for realignment, clearance and tightening of all connections. Failure to follow the above instructions or proper maintenance may void warranty.

ROAD TESTING:

1. Start the engine with the transmission in neutral or park, and the parking brake engaged. Listen for air leaks or odd noises. For air leaks secure hoses and connections. For odd noises, find cause and repair before proceeding. This kit will function identically to the factory system except for being louder and much more responsive.

2. Test drive the vehicle. Listen for odd noises or rattles and fix as necessary.

3. If road test is fine, you can now enjoy the added power and performance from your kit.

4. K&N Engineering, Inc., suggests checking the air filter element periodically for excessive dirt build-up. When the element becomes covered in dirt (or once a year), service it according to the instructions on the Recharger® service kit, part number 99-5050 or 99-5000

INTAKE SYSTEMS FOR VEHICLES LISTED ARE 50 STATE LEGAL. SEE KNFILTERS.COM FOR CARB STATUS ON EACH PART FOR A SPECIFIC VEHICLE.