



TYPHOON INTAKE SYSTEMS

INTAKE SYSTEMS FOR VEHICLES LISTED ARE 50 STATE LEGAL. SEE KNFILTERS.COM FOR CARB STATUS ON EACH PART FOR A SPECIFIC VEHICLE.

INSTALLATION INSTRUCTIONS

69-6000TP
69-6000TR
MAZDA
1999-05 Miata
L4-1.8L

TOOLS NEEDED:

- Flat Blade Screwdriver
- Phillips Screwdriver
- Needle Nose Pliers
- 4mm Allen Wrench
- Ratchet
- 6" Ratchet Extension
- 14" Ratchet Extension
- 10mm Socket
- 12mm Socket

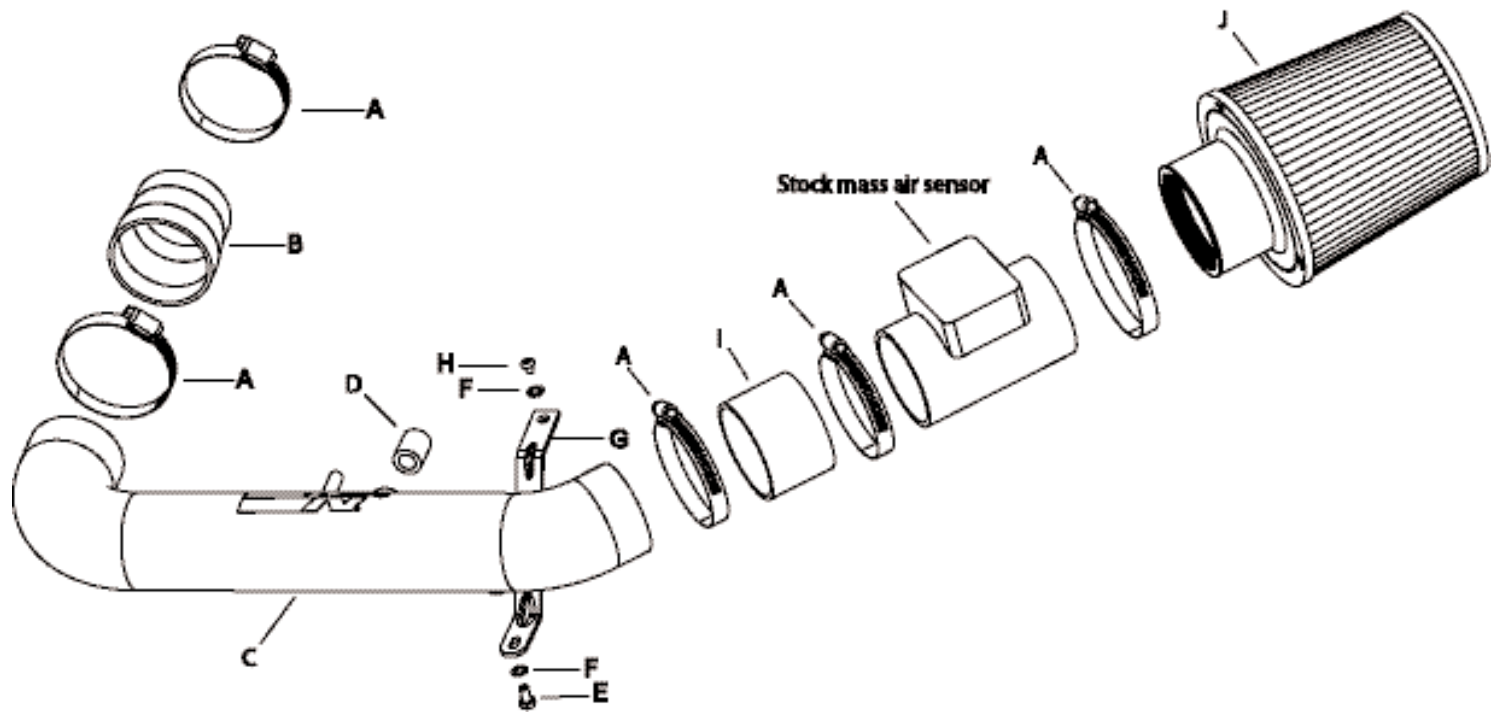

PARTS LIST:

Desc.	Qty.	Part #	Desc.	Qty.	Part #
A Hose Clamp, #44	5	08560	F Wave Washer	2	08277
B Silicone Step Hose, Black	1	084016	G Bracket "Z"	1	070031
C Intake Tube	1	27085	H Bolt, 6mm x 12mm L.	1	07727
D Hose, 17/32"ID x 11/16"	1	084054	I Silicone Hose, Black	1	08440
E Bolt, 6mm x 16mm L.	1	07730	J Air Filter	1	RU-4870

NOTE: FAILURE TO FOLLOW INSTALLATION INSTRUCTIONS AND NOT USING THE PROVIDED HARDWARE MAY DAMAGE THE INTAKE TUBE, THROTTLE BODY AND ENGINE.

TO START:

1. Turn off the ignition and disconnect the negative battery cable.

NOTE: Disconnecting the negative battery cable erases pre-programmed electronic memories. Write down all memory settings before disconnecting the negative battery cable. Some radios will require an anti-theft code to be entered after the battery is reconnected. The anti-theft code is typically supplied with your owner's manual. In the event your vehicles' anti-theft code cannot be recovered, contact an authorized dealership to obtain your vehicles anti-theft code.



2. Disconnect the mass air sensor electrical connection as shown.

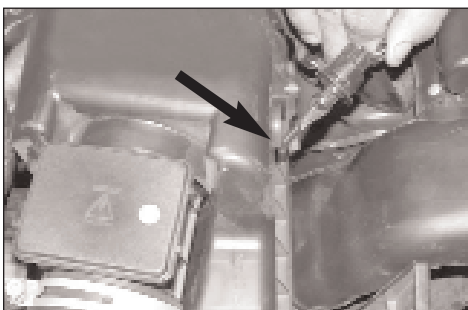

3. Remove the air temperature sensor from the air cleaner assembly as shown.

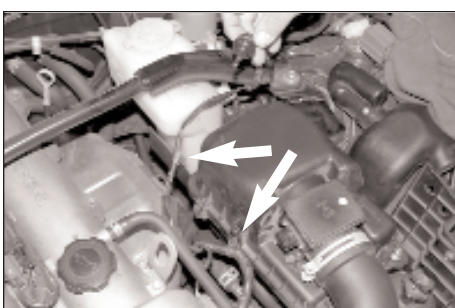

4. Unclip the air temperature sensor electrical connection from the air cleaner assembly as shown.

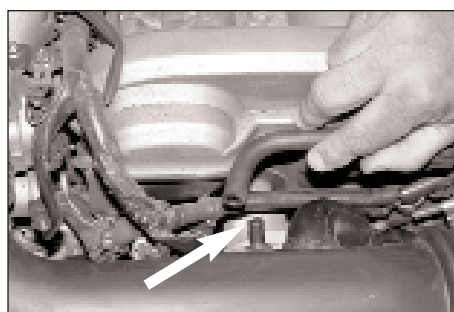

5. Disconnect the crankcase vent hose from the stock intake tube as shown.



6. Loosen the hose clamps at the throttle body and at the mass air sensor, then remove the stock intake tube as shown.



7. Loosen and remove the bolt that secures the air inlet duct to the inner fender, then remove the air inlet duct as shown.

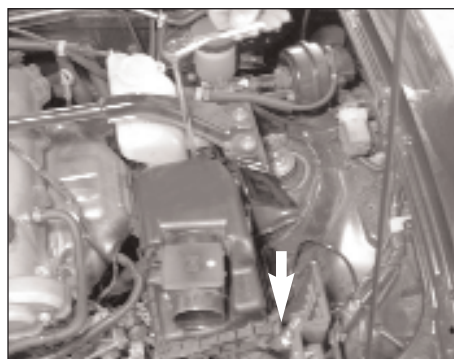

8. Loosen and remove the hex bolt and nut that secure the air cleaner assembly as shown.

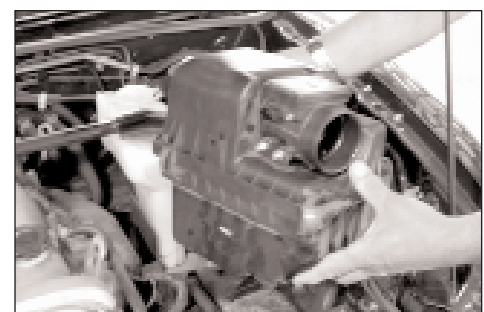

9. Pull upwards to remove the air cleaner assembly as shown. **NOTE: K&N Engineering, Inc., recommends that customers do not discard factory air intake.**

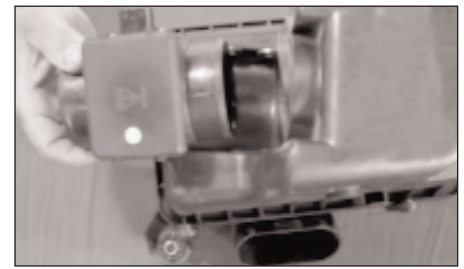

10. Loosen and remove the two bolts that secure the mass air sensor, then remove the mass air sensor as shown.

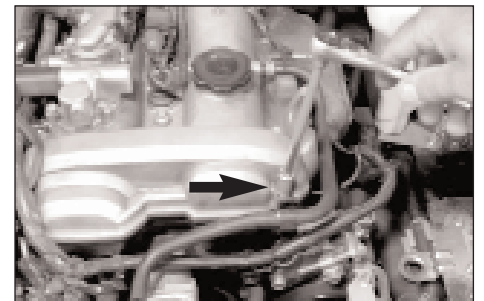

11. Remove the bolt that secures the crankcase vent hose bracket to the cam cover as shown.



12. Install the silicone step hose and hose clamps onto the K&N intake tube as shown.



13. Install the silicone straight hose and hose clamps onto the K&N® intake tube as shown.

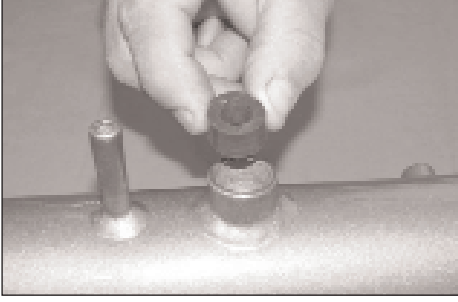

14. Install the silicone sleeve into the air temperature sensor bung on the K&N® intake tube as shown.

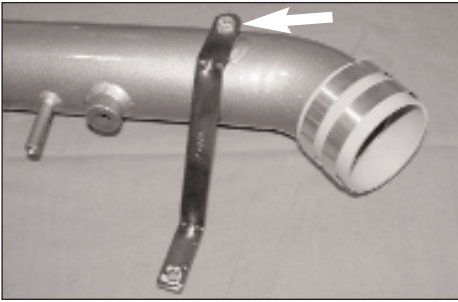

15. Install the "Z" bracket onto the K&N® intake tube using the provided hardware as shown.

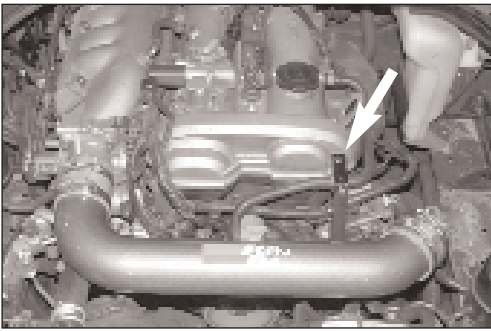

16. Install the K&N® intake tube onto the throttle body, then, line up the bracket with the threaded hole from step 11.

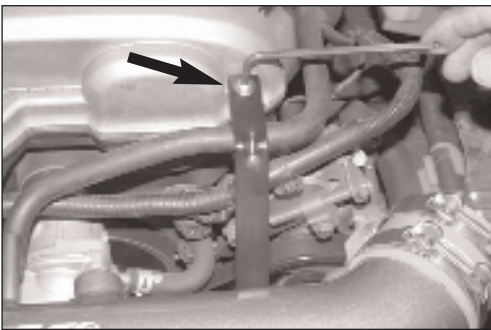

17. Using the provided hex bolt secure the bracket to the cam cover as shown.

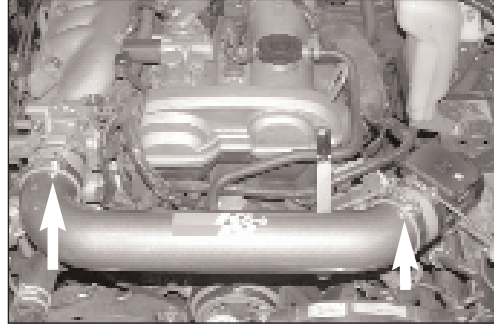

18. Slide the mass air sensor into the silicone hose, then, tighten all hose clamps as shown.

NOTE: The arrow on the side of the mass air sensor specifies the correct direction of the airflow into the engine.



19. Install the K&N® air filter onto the mass air sensor, then, tighten the hose clamp as shown.

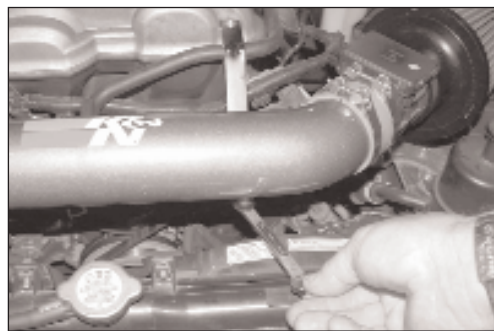

20. Tighten the hex bolt on the K&N® intake tube as shown.

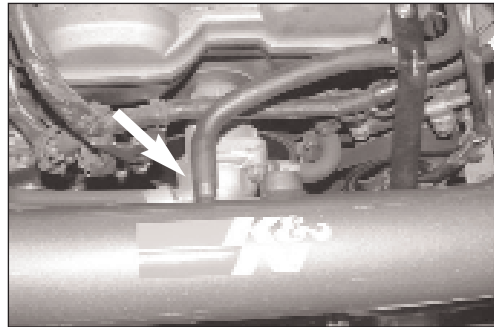

21. Install the crankcase vent hose onto the K&N® intake tube as shown.

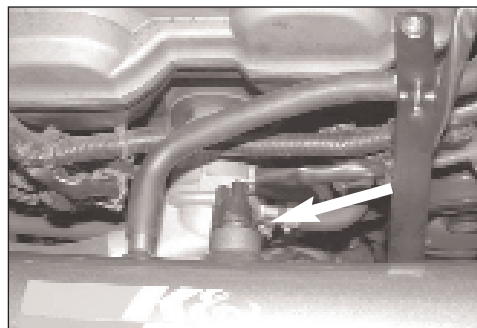

22. Slide the air temperature sensor into the bung on the K&N® intake tube as shown.

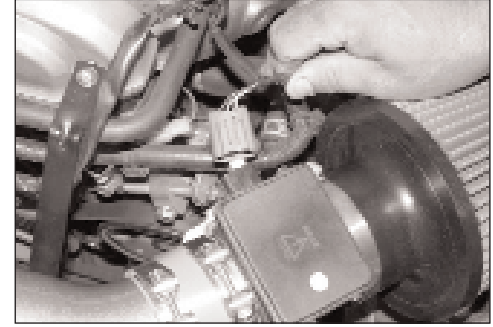

23. Reconnect the mass air sensor electrical connection as shown.

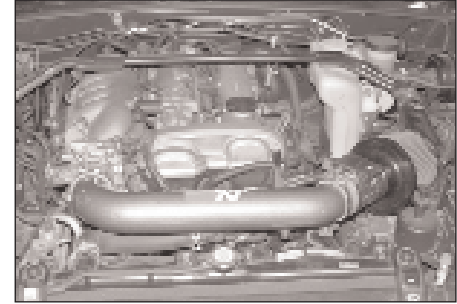

24. Reconnect the vehicle's negative battery cable. Double check to make sure everything is tight and properly positioned before starting the vehicle.

25. The C.A.R.B. exemption sticker, (attached), must be visible under the hood so that an emissions inspector can see it when the vehicle is required to be tested for emissions. California requires testing every two years, other states may vary.

26. It will be necessary for all K&N® high flow intake systems to be checked periodically for realignment, clearance and tightening of all connections. Failure to follow the above instructions or proper maintenance may void warranty.

ROAD TESTING:

1. Start the engine with the transmission in neutral or park, and the parking brake engaged. Listen for air leaks or odd noises. For air leaks secure hoses and connections. For odd noises, find cause and repair before proceeding. This kit will function identically to the factory system except for being louder and much more responsive.

2. Test drive the vehicle. Listen for odd noises or rattles and fix as necessary.

3. If road test is fine, you can now enjoy the added power and performance from your kit.

4. K&N Engineering, Inc., suggests checking the air filter element periodically for excessive dirt build-up. When the element becomes covered in dirt (or once a year), service it according to the instructions on the Recharger® service kit, part number 99-5050 or 99-5000.

SOME INTAKE SYSTEMS ARE NOT LEGAL FOR SALE OR USE ON ANY POLLUTION CONTROLLED MOTOR VEHICLE IN CALIFORNIA OR STATES ADOPTING CALIFORNIA EMISSION PROCEDURES.

See knfilters.com for CARB status on each part for a specific vehicle