



Installation Instructions

For Part Numbers:

200-206-1	720-477 Airaid Oiled Media Filter
201-206-1	721-477 SynthaMax Dry Media Filter - Red
202-206-1	722-477 SynthaMax Dry Media Filter - Black
203-206-1	723-477 SynthaMax Dry Media Filter - Blue

2006-09 Chevrolet Trailblazer 5.3L V8, 6.0L V8
 2005-06 Chevrolet Trailblazer EXT 5.3L V8
 2005-06 GMC Envoy 5.3L V8
 2005-06 GMC Envoy XL 5.3L V8
 2005 GMC Envoy XUV 5.3L V8

Component Identification

1.	Airaid Premium Filter	1
2.	Airaid Intake Tube	1
3.	MAF Panel	1
4.	Silicone Hump Hose	1
5.	CouplerW/#68 Clamp	1
6.	Weather Strip 26"	1
7.	M6 x 25mm Hex Bolt	3
8.	1/4 - 20 x 1/2" Button Head Bolt	1
9.	1/4" Flat Washer	4
10.	1/4 - 20 Serrated Nut	1
11.	8-32 x 1/2" Button Head Screw	3
12.	#8 Flat Washer	3
13.	8-32 Keps Nut	3
14.	#56 Hose Clamp	2
15.	1/4" NPT x 3/8" Barbed Fitting	1
16.	3/8" x 8" Breather Hose	1
17.	Aluminum Spacer	1
18.	Airaid Decal	1

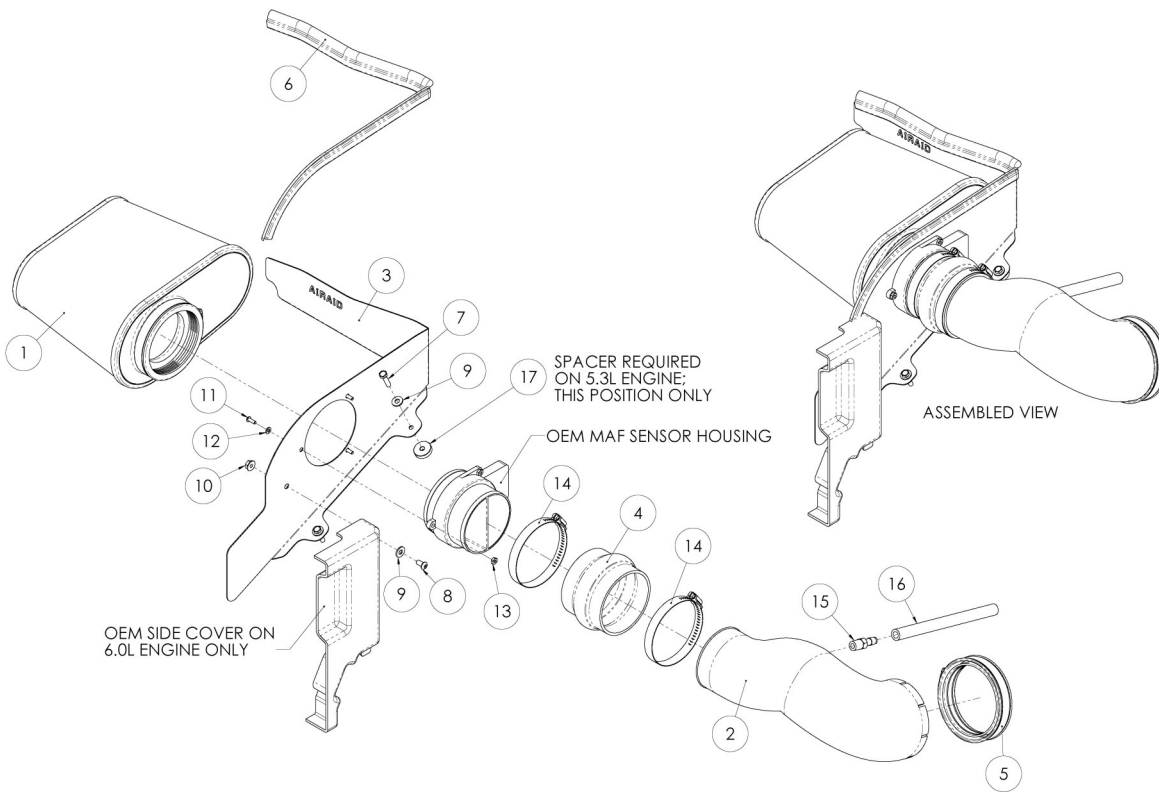

Full color instructions can be viewed on our web site at Airaid.com.



1. Disconnect the negative battery cable.

6.0 Liter Only: Using a T-30 torx bit, remove the factory screw and engine beauty cover, and then set them aside for reuse.



2. Using a 5/16" socket or flat blade screwdriver, loosen the hose clamps on both ends of the factory intake tube.

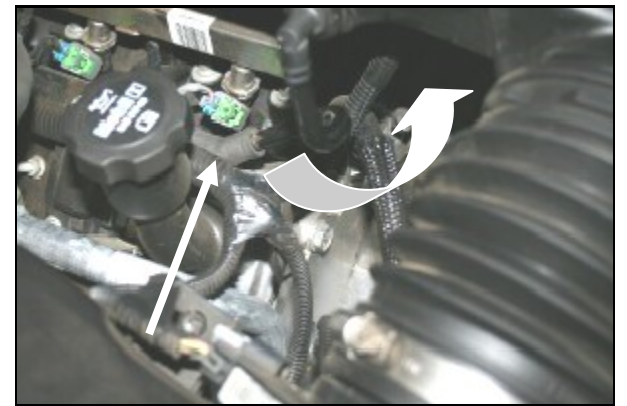

3. Slide the factory breather hose off of the metal tube on the engine.



4. Loosen the clamp holding the Mass Air Flow (MAF) sensor to the factory airbox lid. Remove the complete factory intake and breather tube. Remove the MAF sensor from the lid (*do not disconnect it*), and then set it aside.



5. **6.0 Liter Only:** Using a flat blade screwdriver, gently pry the plastic retaining clip from the oem side cover.

All Models: Loosen the four mounting screws on the factory airbox lid. Remove the factory airbox lid, filter, and resonator as an assembly.



6. Mount the MAF Panel (#3) onto the airbox base using three M6 x 25mm Hex Bolts (#7), and 1/4" flat washers (#9). Apply the Airaid Foil Decal onto the Panel as shown.

5.3 Liter Only: Insert one aluminum spacer (#17) between the panel and the lower airbox in the position as shown. Tighten using a 10mm socket, ratchet and extension.

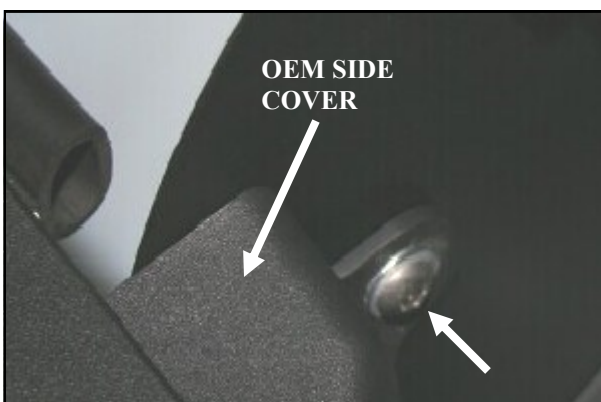

7. **6.0 Liter Only:** Insert one 1/4 - 20 x 1/2" button head bolt (#8) and 1/4" flat washer (#9) through the hole in the oem side cover, and through the hole in the panel. Secure using one 1/4 - 20 serrated nut (#10).

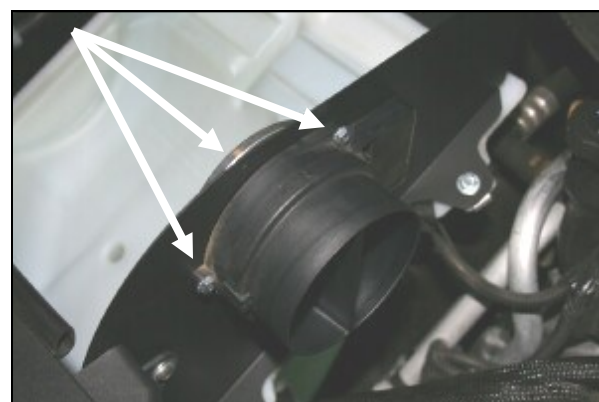

8. Mount the MAF sensor onto the panel using three 8-32 x 1/2" button head screws (#11), #8 flat washers (#12), and 8-32 keps nuts (#13). (Note: sensor should be mounted with "flow" arrow on top).



9. Slide the silicone hump hose (#4), and two #56 hose clamps (#14) onto the MAF sensor. Slide the coupler (#5) and one #68 hose clamp onto the throttle body. Tighten only the clamp on the MAF sensor for now.



10. Insert one 1/4" NPT x 3/8" barbed fitting (#15) into the Airaid Intake Tube (#2).



11. Insert the Airaid Intake Tube (#2) into the hump hose first. Then, insert the throttle body end of the tube into the coupler. Adjust for fit, and tighten the clamps.

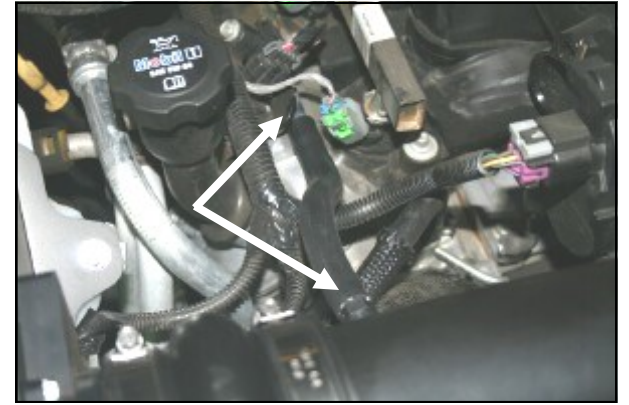

12. Slide one end of the 3/8" x 8" breather hose (#16) over the barbed fitting in the Airaid Intake tube. Slide the other end of the breather hose onto the metal tube on the engine.

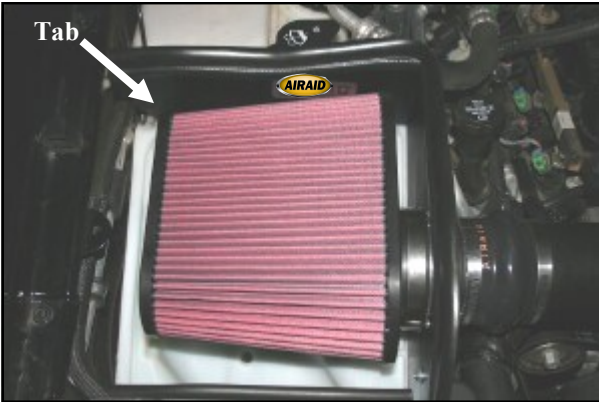

13. Install the Airaid Premium Filter (#1) onto the MAF sensor. Rotate the filter so that the tab contacts the air box base, and then tighten the clamp. Install the weather strip (#6) onto the top of the panel. (Hint: Start at one end and work towards the other.)

14. Double check your work!

Make sure there is no foreign material in the intake path. Make sure all clamps, hoses, bolts, and screws are tight.

15. Reconnect the negative battery cable!

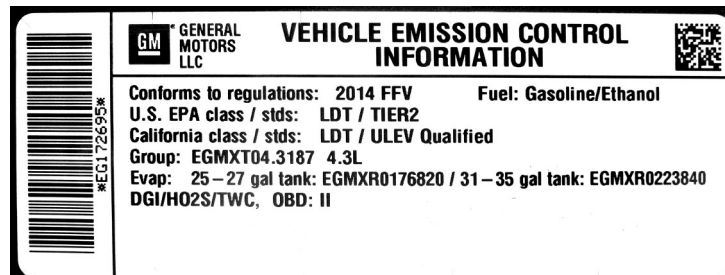

WARNING! If your vehicle has a Vehicle Emission Control Information decal affixed to the factory airbox, a new replacement label must be obtained and installed in a readily visible position in the engine compartment in order to remain CARB compliant. Failure to do so will prevent the vehicle from passing a smog check. Replacement labels can be ordered from your local dealership. Regulations state that the VECI label shall not be affixed to any equipment which is easily detached from the vehicle. Label placement, under the hood on a painted surface is recommended.

Thank you for purchasing the Airaid Intake System. Contact Airaid @ (800) 498-6951 8:00 AM - 5:00 PM MST weekdays for questions regarding fit or instructions that are not clear to you. Your Airaid Intake System was carefully inspected and packaged. Check that no parts are missing, or were damaged during shipping. If any parts are missing, contact Airaid. The air filter element is protected from direct exposure to water and debris; care should be taken not to drive through deep water. WATER INGESTION IS THE DRIVERS RESPONSIBILITY! The air filter is reusable and should be cleaned periodically.

FILTER IDENTIFICATION

720-477 Airaid Oiled Media
722-477 Airaid SynthaMax Dry Media - Black

721-477 Airaid SynthaMax Dry Media - Red
723-477 Airaid SynthaMax Dry Media - Blue

For your Oiled media filter we suggest using the AIRAID Filter Tune-Up Kit!



P/N 790-551 Aerosol Spray
P/N 790-550 Squeeze Spray



SynthaMax

Do Not Oil

Synthamax Air Filters do not require oil. Service air filter as needed by cleaning with common non-petroleum all-purpose household cleaner and water. Simple Green®, Formula 409® or equivalent works great. Apply cleaner to outside of air filter and allow to soak. Then flush filter clean from the inside out with a garden hose and repeat steps if necessary. Do not apply high pressure water or air to clean filter. Allow filter to air dry and reinstall.