



## Installation Instructions

For Part Numbers:

- 310-176 700-452 Airaid Oiled Media Filter
- 311-176 701-452 SynthaMax Dry Media Filter - Red
- 312-176 702-452 SynthaMax Dry Media Filter - Black
- 313-176 703-452 SynthaMax Dry Media Filter - Blue

1991-1995 Jeep Wrangler

2.5L I4

(DOES NOT FIT WITH OPTIONAL ANTI-LOCK BRAKE SYSTEM)

### Component Identification

1.	Airaid Premium Filter	1
2.	MAF Panel	1
3.	Bottom Panel	1
4.	Brace	1
5.	Airaid Intake Tube	1
6.	Urethane Hump Hose	1
7.	2 5/8"x2" Coupler	1
8.	1/2"x14" Breather Hose	1
9.	Weather Strip 31 1/4"	1
10.	6-32x5/16" Screw	5
11.	#6 Flat Washer	5
12.	6-32 Keps Nut	5
13.	1/4-20x5/8" Hex Bolt	3
14.	1/4" Flat Washer	4
15.	1/4" Fender Washer	2
16.	1/4" Lock Nut	3
17.	#44 Hose Clamp	2
18.	#60 Hose Clamp	2
19.	Grommet	1
20.	#14 Black Speed Clamp	2
21.	#16 Black Speed Clamp	3
22.	1/4"NPTx1/2" Barbed Fitting	1
23.	3/8"x4" Hose	1
24.	Airaid Decal	1

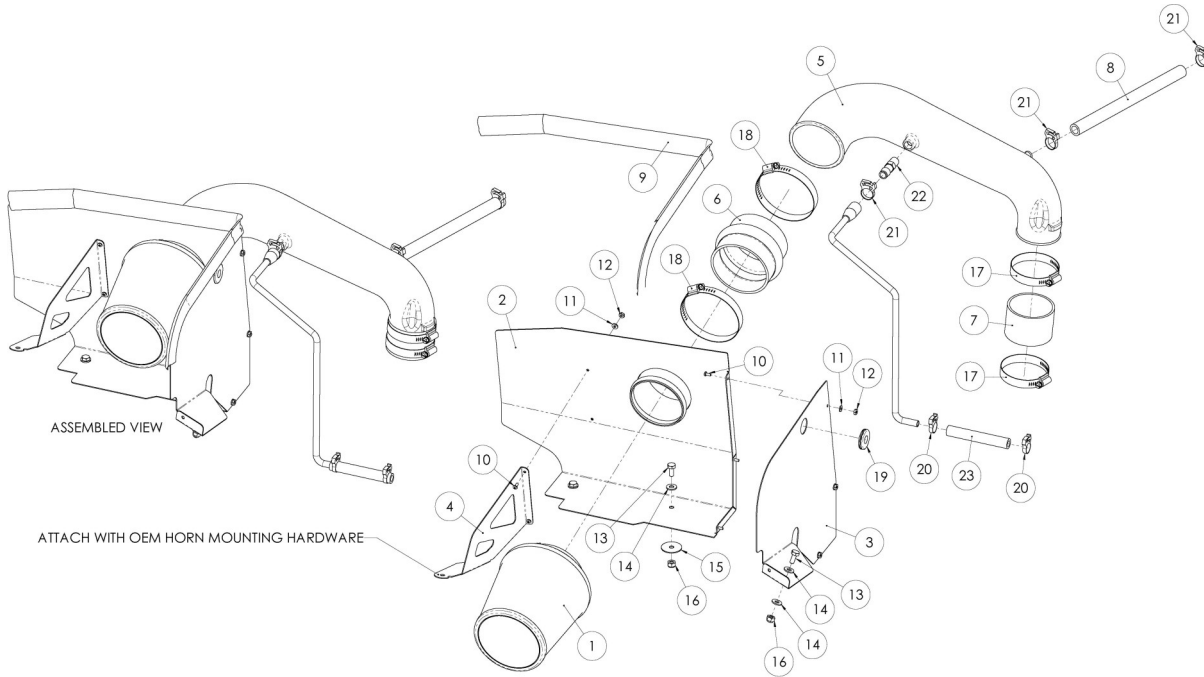

Full color instructions can be viewed on our web site at [Airaid.com](http://Airaid.com).

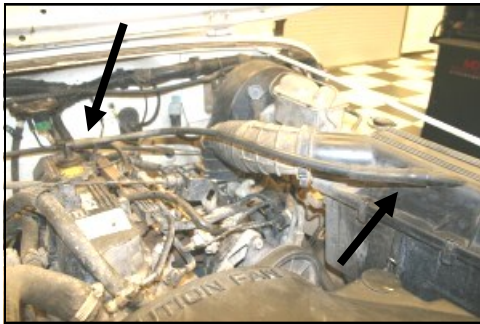

**1. Disconnect the negative battery cable.** Remove the factory valve cover breather hose from the airbox, and the valve cover.



**2.** Disconnect the vacuum line from the airbox and at the canister below the master cylinder. (Save for reuse.)

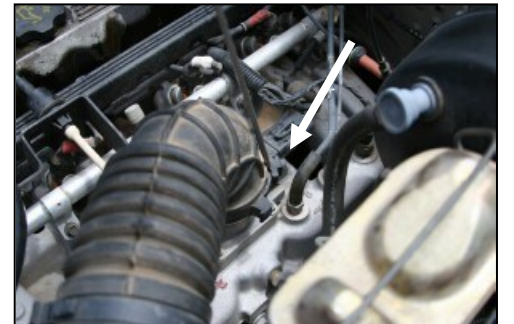

**3.** Pry open the plastic clamp that holds the factory intake tube to the throttle body. Unhook the 3 metal latches on the airbox that hold it to the mounting plate, and remove the intake assembly.



**4.** Remove the two grommets from the airbox mounting plate.

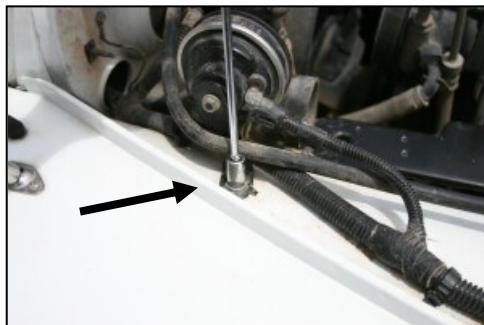

**5.** Using a 10mm socket, remove the horn bolt from the fender. (Save for later use.)



**6.** Carefully remove the wire loom clamp from the hole in the inner fender. Use caution not to damage the clamp, as it will be reused.



**7.** Assemble the Cool Air Dam (CAD) panels (#2, #3, & #4) as shown using the 5 provided screws (#10), washers (#11), and nuts (#12).



**8.** Using a 9/16" wrench, loosen the nut on the radiator support rod, and lift it up out of the slot.

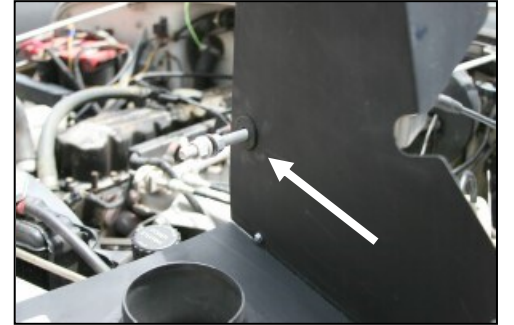

**9.** Carefully slide the CAD over the support rod, and then slide the supplied grommet over the rod, and into the hole in the CAD as shown. Rotate the CAD and place it into position on the factory airbox mount. Re-install the radiator support rod, and tighten the nut.



**10.** Install two 1/4 - 20 x 5/8" hex bolts (#13) and 1/4" flat washers (#14) thru the top of the CAD, and fender washers (#15) and locknuts (#16) on the bottom, where the factory grommets were removed.

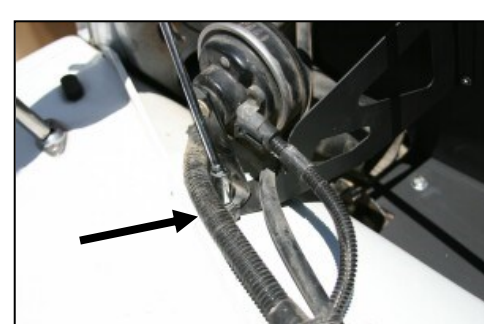

**11.** Slide the CAD bracket under the horn mount and reinstall the factory bolt from step 5.

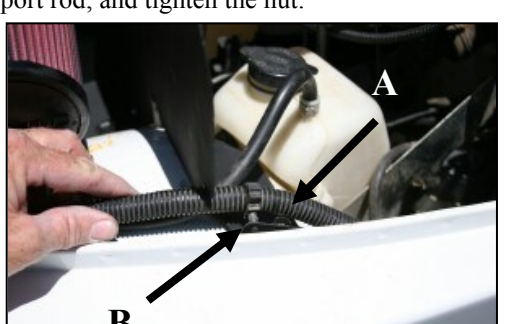

**12.** A) Using a 1/4-20 bolt (#13), 2 washers (#14), and locknut (#16), bolt the CAD to the fender. B) Install the wire loom clamp into the hole in the CAD, as shown.



13. Remove the factory hose from step 2, and install the new 3/8"x4" hose (#23) on the end of the vacuum line as shown. Re-install the vacuum line. (Refer to step 2.)

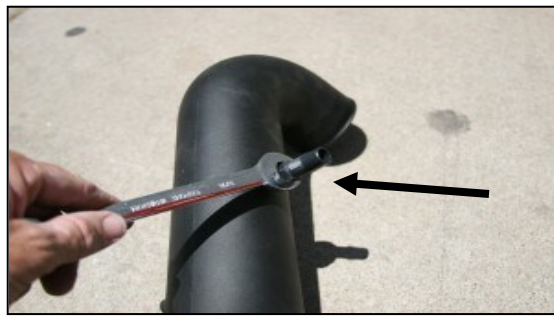

14. Install the 1/4" barbed fitting (#22) into the intake tube.

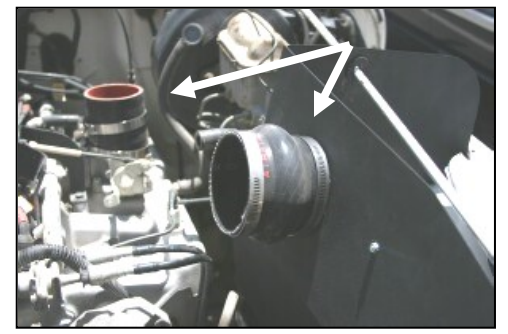

15. Install the urethane hump hose (#6) on the CAD with two #60 hose clamps (#18), and the coupler (#7) on the throttle body with two #44 hose clamps (#17). Leave the clamps loose for now.

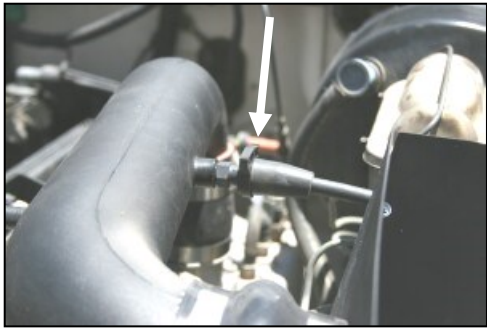

16. Slide intake tube into the hump hose first, and then into the coupler. Adjust for a good fit, and tighten the hose clamps. Slide the vacuum hose on the barbed fitting, and install one #16 speed clamp (#21) as shown.



17. Replace the factory breather hose with the 1/2"x 14" breather hose (#8) between the valve cover and the intake tube using two #16 speed clamps (#21) as shown.

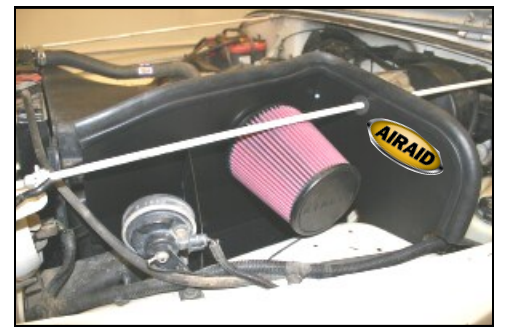

18. Install the Airaid Premium Filter (#1) and the weather strip (#9) onto the CAD, as shown. Apply the Airaid Foil Decal onto the Panel as shown.

### 19. Double check your work!

Make sure there is no foreign material in the intake path. Make sure all clamps, hoses, bolts, and screws are tight. Periodically check all hose clamps for tightness.

### 20. Reconnect the negative battery cable!

Thank you for purchasing the Airaid Intake System. Contact Airaid @ (800) 498-6951 8:00 AM - 5:00 PM MST weekdays for questions regarding fit or instructions that are not clear to you. Your Airaid Intake System was carefully inspected and packaged. Check that no parts are missing, or were damaged during shipping. If any parts are missing, contact Airaid. The air filter element is protected from direct exposure to water and debris; care should be taken not to drive through deep water. WATER INGESTION IS THE DRIVERS RESPONSIBILITY! The air filter is reusable and should be cleaned periodically.

## FILTER IDENTIFICATION

700-452 Airaid Oiled Media  
702-452 Airaid SynthaMax Dry Media - Black

701-452 Airaid SynthaMax Dry Media - Red  
703-452 Airaid SynthaMax Dry Media - Blue

For your Oiled media filter we suggest using the AIRAID Filter Tune-Up Kit!

*SynthaMax*<sup>®</sup>

**Do Not Oil**



P/N 790-551 Aerosol Spray  
P/N 790-550 Squeeze Spray



Synthamax Air Filters do not require oil. Service air filter as needed by cleaning with common non-petroleum all-purpose household cleaner and water. Simple Green®, Formula 409® or equivalent works great. Apply cleaner to outside of air filter and allow to soak. Then flush filter clean from the inside out with a garden hose and repeat steps if necessary. Do not apply high pressure water or air to clean filter. Allow filter to air dry and reinstall.