



Installation Instructions

For Part Numbers:

520-284	720-476 Airaid Oiled Media Filter
521-284	721-476 SynthaMax Dry Media Filter - Red
522-284	722-476 SynthaMax Dry Media Filter - Black
523-284	723-476 SynthaMax Dry Media Filter - Blue

2004-14 Nissan Titan / Armada

2004-10 Infiniti QX56

5.6L V8

Component Identification

1.	Airaid Premium Filter	1
2.	Air Intake Tube	1
3.	Cold Air Box	1
4.	Filter Adapter	1
5.	Silicone Reducer	1
6.	Urethane Hump Hose	1
7.	23" Weather strip	1
8.	#8-32 x 1/2" Button Head Screw	2
9.	1/4-20 x 1/2" Button Head Screw	3
10.	M6x1.0x30 Hex Head Bolt	2
11.	M6x1.0 Acorn Nut	2
12.	1/4" Flat Washer	5
13.	Spacer	2
14.	5/8 Barbed Y Fitting	1
15.	1/2 NPT to 5/8" Barbed Fitting	1
16.	2 1/2" 5/8" Hose	1
17.	#19 Speed Clamp	2
18.	#48 Hose Clamp	1
19.	#64 Hose Clamp	1
20.	#72 Hose Clamp	2
21.	8" Zip Tie	1
22.	Airaid Decal	1

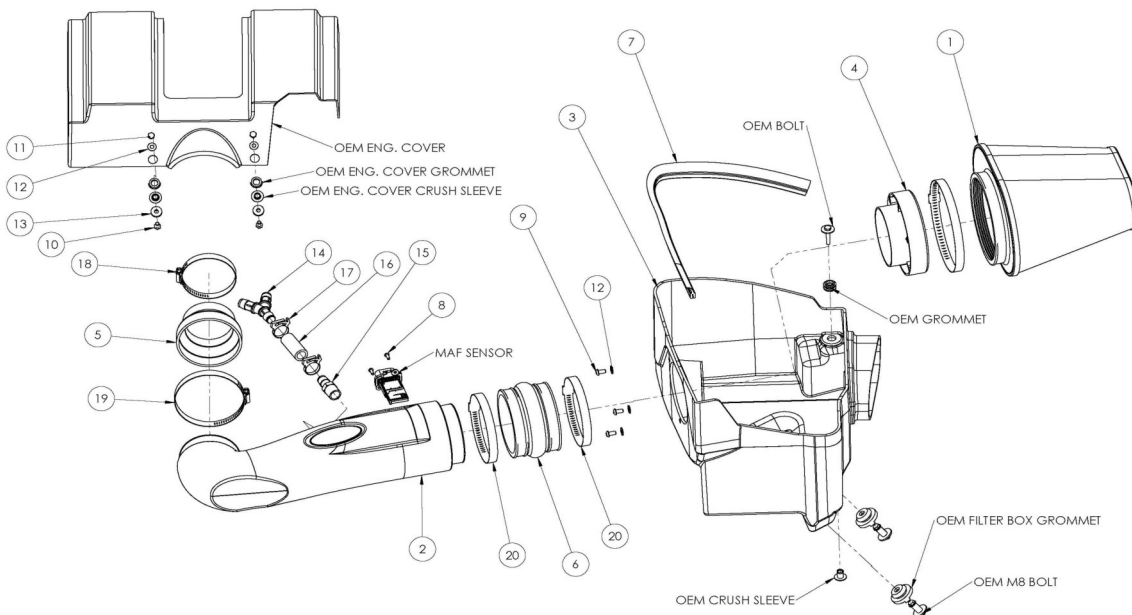

Full color instructions can be viewed on our web site at Airaid.com.

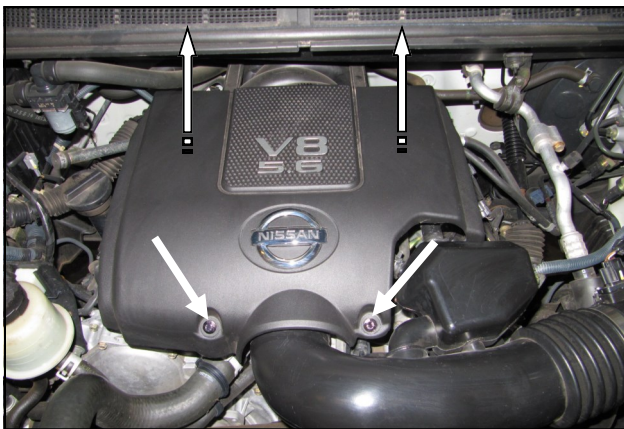

Disconnect The Negative Battery Terminal!

1. Using a 10mm socket, remove the two front engine cover bolts. Lift straight up on the cover and unseat the rear half from its mounting grommets.

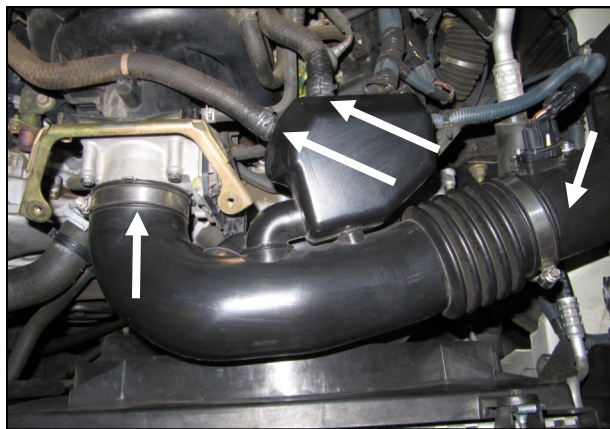

2. A.) Using a pair of pliers, compress the spring clamps on the PCV breathers and then slide back. Disconnect the breathers from the factory intake
B.) Loosen the two clamps on the factory intake tube and remove it from the vehicle.



3. Disconnect the Mass Air Flow sensor, or MAF, and separate the wiring harness from the airbox lid. Using a 10mm socket, remove the single bolt securing the airbox. Lift straight up on the airbox assembly and unseat it from the mounting grommets on the inner fender. 4WD models will need the differential breather disconnected from the airbox lid.

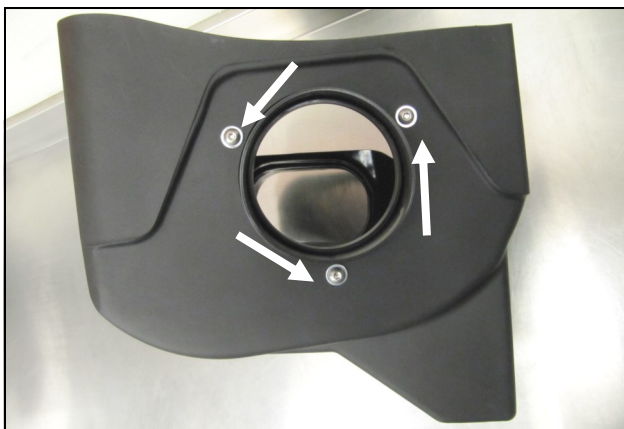

4. Install the Filter Adapter (#4) onto the Cold Air Box (#3), or CAB, as shown using three 1/4-20 Button Head Bolts (#9), and 1/4" Flat Washers (#12). Refer to the line drawing above for details.

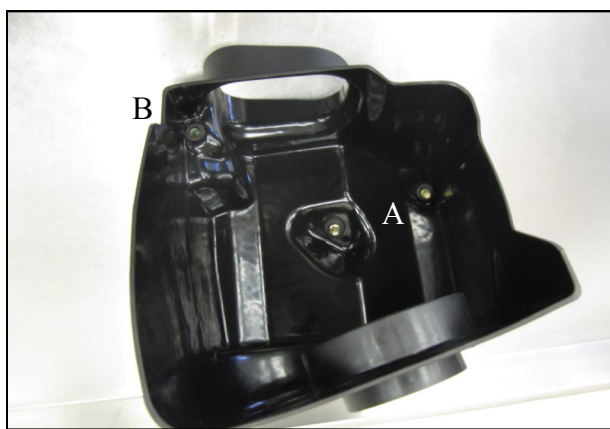

5. Transfer the airbox mounting grommets and hardware from step 3. into the Cold Air Box. A.) Insert the large mounting grommets and bolts from the inner fender into the bottom of the CAB. B.) Remove the small grommet and steel sleeve from the top of the airbox and install it remaining hole in the CAB.

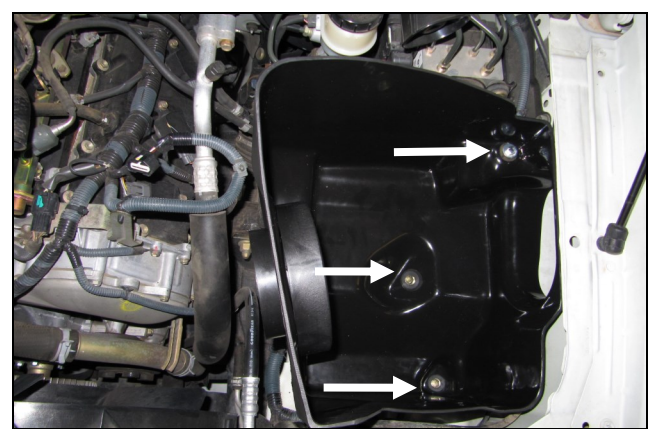

6. Set the CAB assembly inside the engine compartment, align the bolt holes, and secure using the OEM hardware.



7. Install the threaded 5/8" Barbed Fitting (#15) into the Airaid Intake Tube (#2). Transfer the Mass Air Flow sensor from the factory airbox, into the Airaid Intake Tube and secure using the two 8-32 Button Head Screws. Do not attempt to reuse the factory screws. Apply the Airaid Decal to the Tube as shown.



8. Slip the Silicone Reducer (#5) onto the Intake Tube as shown. Slide the #64 Clamp (#19) onto the Reducer first, followed by the #48 Clamp (#18). Leave the Clamps loose for now.



9. Slide the Hump Hose (#6) and #72 Hose Clamps (#20) onto the Filter Adapter. Leave the clamps loose for now.



10. Install the Airaid Intake Tube into the Hump Hose first, and then into the Reducing Coupler. Adjust for fit, and tighten all four Hose Clamps.

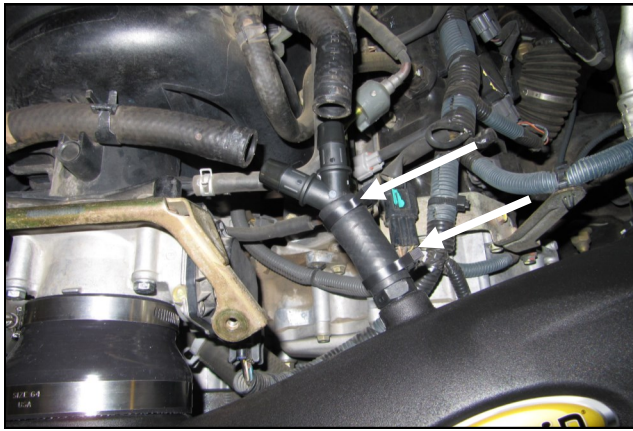

11. Install the 5/8" Hose (#16) onto the Barbed fitting in the Intake Tube. Insert the Barbed "Y" Fitting (#14) into the 5/8" Hose and secure using the two Speed Clamps (#17).

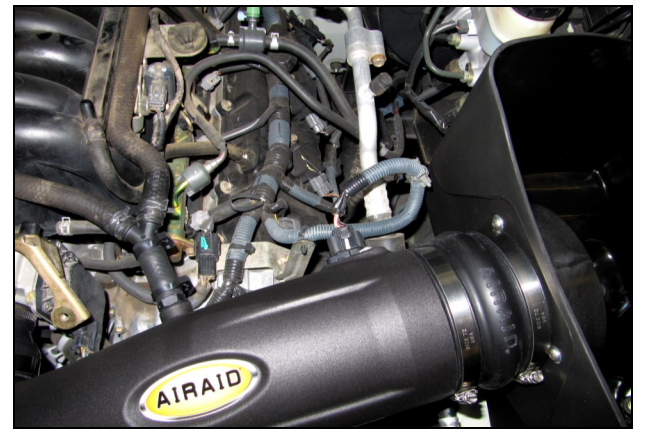

12. Reconnect the factory PCV breathers and spring clamps to the Barbed "Y" Fitting. Reconnect the Mass Air Flow sensor.

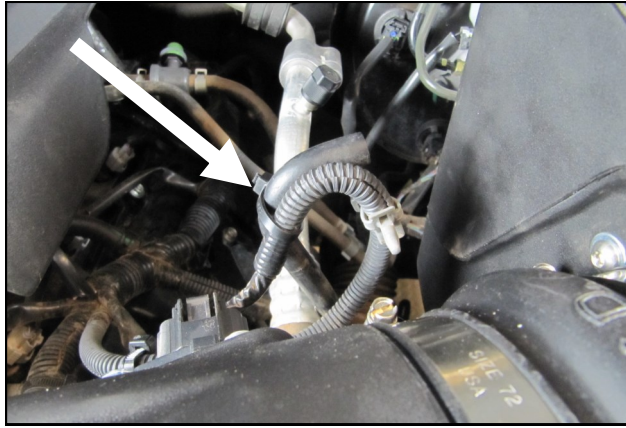

13. On 4WD models: Secure the differential breather to the MAF harness with the 8" Zip Tie. Trim off the excess.



14. Remove the factory engine cover mounting bracket from the intake manifold and install the two 6mm x30mm Bolts (#10) as shown. They are to be installed from behind and protrude forward when installed properly.

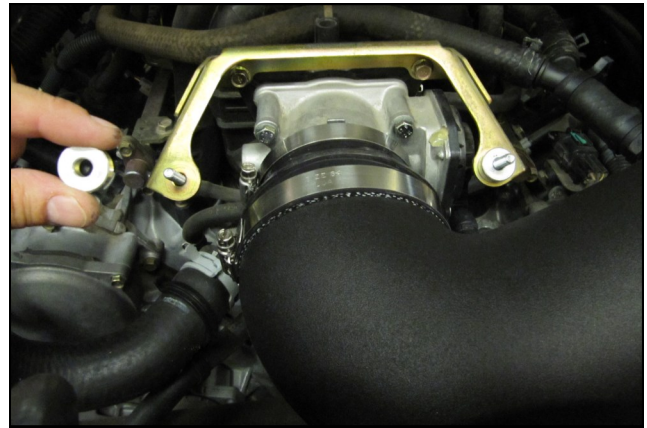

15. Reinstall the bracket onto the intake manifold and place a Spacer (#13) onto each 6mm bolt.



16. Install the Airaid Premium Filter (#1) onto the Filter Adapter then install the Weather Strip (#7) onto the top of the Cold Air Box with the contour rolling away from the Filter.



17. Reinstall the engine cover in the reverse order in which it was removed, rear first, front last. Only now it is to be secured using the two Acorn Nuts (#11) and two 1/4" flat washers.

18. Double check your work!

Make sure there is no foreign material in the intake path. Make sure all clamps, hoses, bolts, and screws are tight. Double check the hood clearance!

Reconnect the negative battery cable!

Thank you for purchasing the Airaid Intake System. Contact Airaid @ (800) 498-6951 8:00 AM - 5:00 PM MST weekdays for questions regarding fit or instructions that are not clear to you. Your Airaid Intake System was carefully inspected and packaged. Check that no parts are missing, or were damaged during shipping. If any parts are missing, contact Airaid. The air filter element is protected from direct exposure to water and debris; care should be taken not to drive through deep water. WATER INGESTION IS THE DRIVERS RESPONSIBILITY! The air filter is reusable and should be cleaned periodically.

FILTER IDENTIFICATION

720-476 Airaid Oiled Media
722-476 Airaid SynthaMax Dry Media - Black

721-476 Airaid SynthaMax Dry Media - Red
723-476 Airaid SynthaMax Dry Media - Blue

For your Oiled media filter we suggest using the AIRAID Filter Tune-Up Kit!



P/N 790-551 Aerosol Spray
P/N 790-550 Squeeze Spray



Do Not Oil

Synthamax Air Filters do not require oil. Service air filter as needed by cleaning with common non-petroleum all-purpose household cleaner and water. Simple Green®, Formula 409® or equivalent works great. Apply cleaner to outside of air filter and allow to soak. Then flush filter clean from the inside out with a garden hose and repeat steps if necessary. Do not apply high pressure water or air to clean filter. Allow filter to air dry and reinstall.